

# HF7FD

# SUBMINIATURE HIGH POWER RELAY



File No.:E134517



File No.: 40008374



File No.:CQC16002153649



## Features

- 16A switching capability
- TV-8 load capability
- 2kV dielectric strength (between coil and contacts)
- Ambient temperature meets 105°C
- Product in accordance to IEC 60335-1 available
- Double pins type available
- 1 Form A and 1 Form C configurations
- UL insulation system:Class F

RoHS compliant

## CONTACT DATA

Contact arrangement	1A	1C	
Contact resistance <sup>1)</sup>	≤ 100mΩ (1A 24VDC)		
Contact material	AgSnO <sub>2</sub>		
Contact rating (Res.load)	16A 250VAC 12A 250VAC 10A 250VAC	NO: 16A 250VAC 12A 250VAC 7A 250VAC/28VDC NC: 7A 250VAC/28VDC	
Max. switching voltage	277VAC / 28VDC		
Max. switching current	16A	16A	
Max. switching power	4000VA / 280W	4000VA / 280W	
Mechanical endurance	1 x 10 <sup>7</sup> OPS		
Electrical endurance (See approval reports for more details)	HF7FD	1A	85°C 16A 250VAC 5 x 10 <sup>6</sup> OPS Resistive load, 1s on 9s off 85°C 12A 250VAC 1 x 10 <sup>6</sup> OPS Resistive load, 1s on 9s off
		1C	NO: 85°C 16A 250VAC 5 x 10 <sup>6</sup> OPS Resistive load, 1s on 9s off 85°C 12A 250VAC 1 x 10 <sup>6</sup> OPS Resistive load, 1s on 9s off NC: 85°C 7A 277VAC 5 x 10 <sup>6</sup> OPS Resistive load, 5s on 5s off 85°C 10A 250VAC 1 x 10 <sup>6</sup> OPS Resistive load, 1s on 9s off
	HF7FD-T	1A	105°C 10A 250VAC 1 x 10 <sup>6</sup> OPS Resistive load, 1s on 9s off 85°C 16A 250VAC 5 x 10 <sup>6</sup> OPS Resistive load, 1s on 9s off
		1C	NO: 105°C 10A 250VAC 1 x 10 <sup>6</sup> OPS Resistive load, 1s on 9s off 85°C 16A 250VAC 5 x 10 <sup>6</sup> OPS Resistive load, 1s on 9s off

Notes: 1) The data shown above are initial values.  
2) Open the air permeability hole when testing plastic encapsulated products.

## CHARACTERISTICS

Insulation resistance	100MΩ (at 500VDC)	
Dielectric strength	Between coil & contacts	2000VAC 1min
	Between open contacts	750VAC 1min
Operate time (at nomi. volt.)	10ms max.	
Release time (at nomi. volt.)	5ms max.	
Humidity	5% to 85% RH	
Shock resistance	Functional	98m/s <sup>2</sup>
	Destructive	980m/s <sup>2</sup>
Ambient temperature	-40°C to 105°C	
Vibration resistance	10Hz to 55Hz 1.5mm DA	
Termination	PCB	
Unit weight	Approx. 9.5g	
Construction	Plastic sealed, Flux proofed	

Notes: 1) The data shown above are initial values.  
2) If the ambient temperature is higher than 85°C, please contact Hongfa.



HONGFA RELAY

ISO9001, ISO/TS16949, ISO14001, OHSAS18001, IECQ QC 080000 CERTIFIED

2019 Rev. 1.01

## COIL

Coil power Approx. 360mW

## COIL DATA

at 23°C

Nominal Voltage VDC	Pick-up Voltage VDC max. <sup>1)</sup>	Drop-out Voltage VDC min. <sup>1)</sup>	Max. Voltage VDC <sup>2)</sup>	Coil Resistance Ω
3	≤2.25	≥0.3	3.9	25 x (1±10%)
5	≤3.75	≥0.5	6.5	70 x (1±10%)
6	≤4.50	≥0.6	7.8	100 x (1±10%)
9	≤6.75	≥0.9	11.7	225 x (1±10%)
12	≤9.00	≥1.2	15.6	400 x (1±10%)
18	≤13.5	≥1.8	23.4	900 x (1±10%)
24	≤18.0	≥2.4	31.2	1600 x (1±15%)
48	≤36.0	≥4.8	62.4	6400 x (1±15%)

Notes: 1) The data shown above are initial values.  
2) \*Maximum voltage refers to the maximum voltage which relay coil could endure in a short period of time.

## SAFETY APPROVAL RATINGS

UL/CUL	HF7FD	1 Form A	16A 250VAC(85°C) 12A 250VAC(85°C, Double pin) 12A 250VAC(85°C, Single pin) 12A 125VAC(85°C) 10A 277VAC/250VAC(85°C) 10A 28VDC(85°C) 10A 250VAC(105°C) TV-8 120VAC(40°C)
		1 Form C	NO:16A 250VAC(85°C) 12A 250VAC(85°C) 12A 125VAC(85°C) 10A 277VAC/250VAC(85°C) 10A 250VAC(105°C) 10A 28VDC(85°C) 7A 277VAC(85°C) 7A 28VDC(85°C) TV-8 120VAC(40°C) NC:12A 125VAC(85°C) 10A 250VAC(85°C) 7A 277VAC(85°C) 7A 28VDC(85°C)
	HF7FD-T	1 Form A	16A 250VAC(85°C) 10A 250VAC(105°C) 8A 250VAC(105°C) 80W 120VAC Tungsten(105°C) 1/2HP 125VAC(40°C) 1/2HP 250VAC(40°C) TV-8 120VAC(40°C)
		1 Form C	NO:16A 250VAC(85°C) 10A 250VAC(105°C) 8A 250VAC(105°C) 80W 120VAC Tungsten(105°C) 1/2HP 125VAC(40°C) 1/2HP 250VAC(40°C) TV-8 120VAC(40°C) NC:12A 125VAC(85°C) 10A 277VAC/250VAC(85°C) 7A 277VAC(85°C)
VDE	HF7FD	1 Form A	10A 250VAC(85°C) 12A 250VAC(70°C)
		1 Form C	CO:10A 250VAC(85°C) 7A 250VAC(85°C)
	HF7FD-T	1 Form C	12A 250VAC(105°C)

Notes: Only typical loads are listed above. Other load specifications can be available upon request.

## ORDERING INFORMATION

<b>HF7FD / 012 -1H P S T F (XXX)</b>	
<b>Type</b>	HF7FD, HF7FD-T
<b>Coil voltage</b>	3, 5, 6, 9, 12, 18, 24, 48VDC
<b>Contact arrangement</b>	1H: 1 Form A 1Z: 1 Form C
<b>Pin version</b>	P: Double pins type Nil: Single pin type
<b>Construction<sup>1)</sup></b>	S: Plastic sealed Nil: Flux proofed
<b>Contact material</b>	T: AgSnO <sub>2</sub>
<b>Insulation standard</b>	F: Class F
<b>Special code<sup>1)</sup></b>	XXX: Customer special requirement Nil: Standard

- Notes:** 1) Under the ambience with dangerous gas like H<sub>2</sub>S, SO<sub>2</sub> or NO<sub>2</sub>, plastic sealed type is recommended; Please test the relay in real applications. If the ambience allows, flux proofed type is preferentially recommended.  
 2) Contact is recommended for suitable condition and specifications if water cleaning or surface process is involved in assembling relays on PCB.  
 3) If plastic sealed type is selected for cleaning purpose, the vent-hole cover should be excised after cleaning.

## OUTLINE DIMENSIONS, WIRING DIAGRAM AND PC BOARD LAYOUT

Unit: mm

Outline Dimensions

Wiring Diagram  
(Bottom view)

PCB Layout  
(Bottom View)

1 Form A (Single pin type)

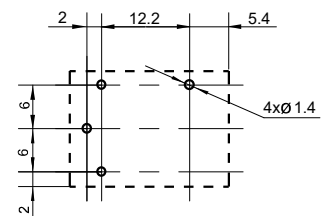
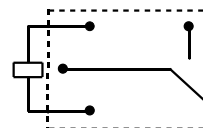
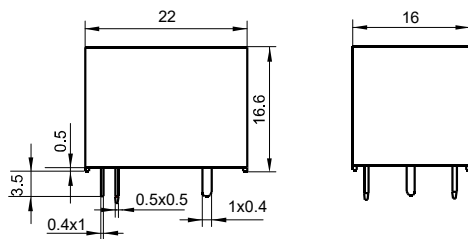

1 Form C (Single pin type)

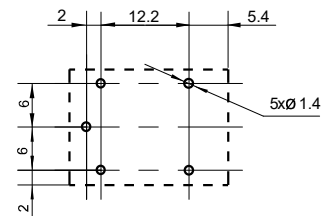
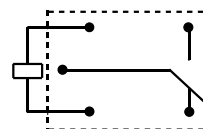
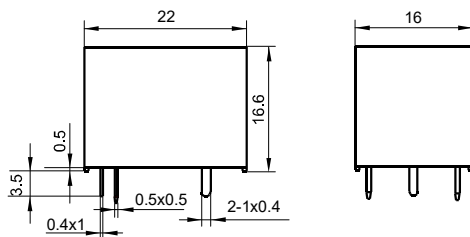

# OUTLINE DIMENSIONS, WIRING DIAGRAM AND PC BOARD LAYOUT

Unit: mm

## Outline Dimensions

## Wiring Diagram (Bottom View)

## PCB Layout (Bottom view)

### 1 Form A (Double pins type)

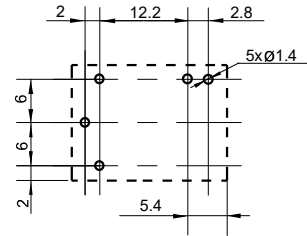
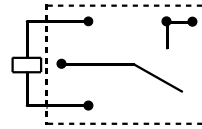
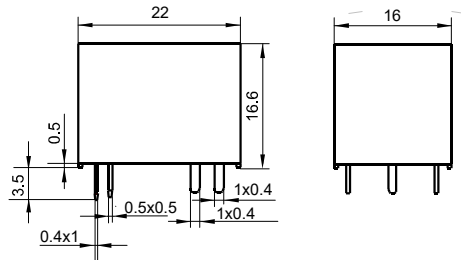

### 1 Form C (Double pins type)

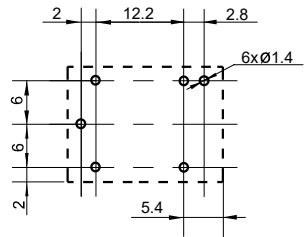
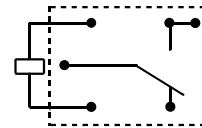
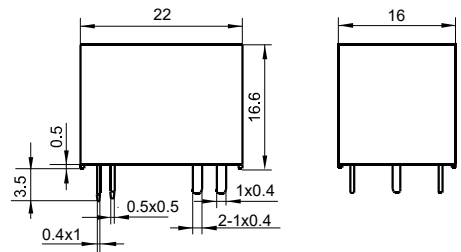

- Remark: 1) The pin dimension of the product outline drawing is the size before tinning (it will become larger after tinning), and the mounting hole size is the recommended design size of the PCB board hole. The specific PCB board hole design size can be mapped and adjusted according to the actual product.  
 2) In case of no tolerance shown in outline dimension: outline dimension  $\leq 1$ mm, tolerance should be  $\pm 0.2$ mm; outline dimension  $> 1$ mm and  $\leq 5$ mm, tolerance should be  $\pm 0.3$ mm; outline dimension  $> 5$ mm, tolerance should be  $\pm 0.4$ mm.  
 3) The tolerance without indicating for PCB layout is always  $\pm 0.1$ mm.

## CHARACTERISTIC CURVES

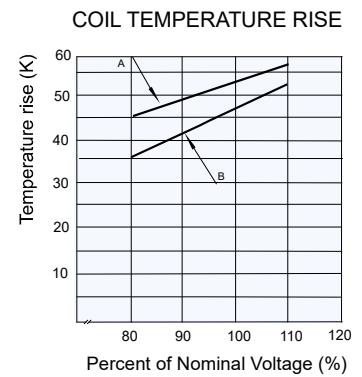
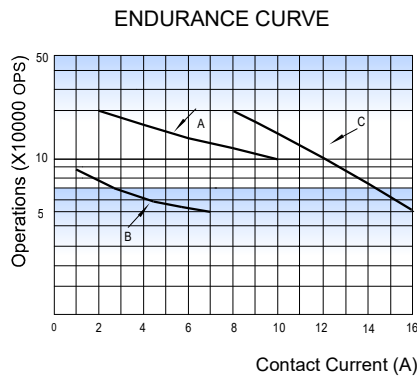
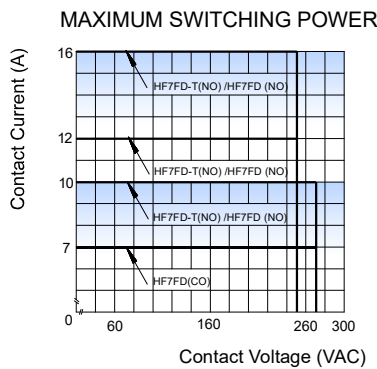

#### Test conditions:

- Curve A: NO, Resistive load, 85°C, flux proofed, 10A 277VAC, 1s on 9s off  
 Curve B: CO, Resistive load, 85°C, flux proofed, 7A 277VAC, 5s on 5s off  
 Curve C: NO, Resistive load, Room temp., flux proofed, 16A 250VAC, 1s on 9s off

#### Test conditions::

- A: 16A at 85°C.  
 B: 10A at 85°C.  
 Mounting distance: 25mm

### Disclaimer

The specification is for reference only. See to "Terminology and Guidelines" for more information. Specifications subject to change without notice. We could not evaluate all the performance and all the parameters for every possible application. Thus the user should be in a right position to choose the suitable product for their own application. If there is any query, please contact Hongfa for the technical service. However, it is the user's responsibility to determine which product should be used only.

© Xiamen Hongfa Electroacoustic Co., Ltd. All rights of Hongfa are reserved.