

HF13F

MINIATURE INTERMEDIATE POWER RELAY



File No.:E133481



File No.:R50154518



File No.:CQC09002030028 (DC type)
CQC09002030029 (AC type)



Features

- 1C: 15A; 2C:10A switching capability
- Various terminals available
- Sockets available
- Conform to the CE low voltage directive
- 1 & 2 pole configurations
- UL insulation system: Class F(2 form A/2 form C)

RoHS compliant

CONTACT DATA

Contact arrangement	1A,1C	2A,2C
Contact resistance ¹⁾	100mΩ max.(at 1A 6VDC)	
Contact material	See ordering info.	
Contact rating (Res. load)	15A 250VAC/30VDC	10A 250VAC/30VDC
Max. switching voltage	250VAC / 30VDC	
Max. switching current	15A	10A
Max. switching power	3750VA/450W	2500VA/300W
Mechanical endurance	1 x 10 ⁷ OPS	
Electrical endurance	1Z type: 1 x 10 ⁵ OPS (15A 250VAC, Resistive load, Room temp., 1s on 9s off) 1Z type: 1 x 10 ⁵ OPS (15A 30VDC, Resistive load, Room temp., 1s on 9s off) 2Z type: 1 x 10 ⁵ OPS (10A 250VAC, Resistive load, Room temp., 1s on 9s off) 2Z type: 1 x 10 ⁵ OPS (10A 30VDC, Resistive load, Room temp., 1s on 9s off)	

Notes: The data shown above are initial values.

CHARACTERISTICS

Insulation resistance	500MΩ (at 500VDC)	
Dielectric strength	Between coil & contacts	1500VAC 1min
	Between open contacts	1000VAC 1min
	Between contact sets	1500VAC 1min
Operate time (at nomi. volt.)	25ms max.	
Release time (at nomi. volt.)	25ms max.	
Temperature rise (no-load, at nomi.volt.)	60K max.	
Shock resistance	Functional	98m/s ²
	Destructive	980m/s ²
Vibration resistance	10Hz to 55Hz 1mm DA	
Humidity	5% to 85% RH	
Ambient temperature	-40°C to 70°C	
Termination	PCB, Plug-in	
Unit weight	Approx. 37g	
Construction	Dust protected	

Notes: The data shown above are initial values.

COIL

Coil power	DC type: Approx. 0.9W to 1.1W AC type: Approx. 1.2VA to 1.8VA
------------	--

COIL DATA

at 23°C

1 Pole				
Nominal Voltage VDC	Pick-up Voltage VDC max. ²⁾	Drop-out Voltage VDC min. ²⁾	Max. Voltage VDC ³⁾	Coil Resistance Ω
5	≤4.0	≥0.5	5.5	27.5x(1±10%)
6	≤4.8	≥0.6	6.6	40x(1±10%)
9	≤7.2	≥0.9	9.9	90x(1±10%)
12	≤9.6	≥1.2	13.2	160x(1±10%)
21	≤16.8	≥2.1	23.1	490x(1±10%)
24	≤19.2	≥2.4	26.4	650x(1±10%)
30	≤24.0	≥3.0	33.0	1000x(1±10%)
36	≤28.8	≥3.6	39.6	1440x(1±10%)
48	≤38.4	≥4.8	52.8	2600x(1±15%)
60	≤48.0	≥6.0	66.0	4000x(1±15%)
110	≤88.0	≥11.0	121	11000x(1±15%)
125	≤100.0	≥12.5	137.5	14000x(1±15%)
220	≤176.0	≥22.0	242	53750x(1±15%)

Nominal Voltage VAC	Pick-up Voltage VAC max. ²⁾	Drop-out Voltage VAC min. ²⁾	Max. Voltage VAC ³⁾	Coil Resistance Ω
6	≤4.80	≥1.8	6.6	11.5x(1±10%)
12	≤9.60	≥3.6	13.2	46x(1±10%)
24	≤19.2	≥7.2	26.4	184x(1±10%)
36	≤28.8	≥10.8	39.6	410x(1±10%)
48	≤38.4	≥14.4	52.8	735x(1±10%)
60	≤48.0	≥18.0	66.0	1100x(1±10%)
120 ⁴⁾	≤96.0	≥36.0	132	4550x(1±15%)
200	≤160	≥66.0	220	12950x(1±15%)
220	≤176	≥72.0	242	14400x(1±15%)
240 ⁴⁾	≤176	≥72.0	264	14400x(1±15%)
277	≤221.6	≥83.1	304.7	23590x(1±15%)



HONGFA RELAY

ISO9001, ISO/TS16949, ISO14001, OHSAS18001, IECQ QC 080000 CERTIFIED

2018 Rev. 1.01

COIL DATA

at 23°C

2 Pole

Nominal Voltage VDC	Pick-up Voltage VDC max. ²⁾	Drop-out Voltage VDC min. ²⁾	Max. Voltage VDC ³⁾	Coil Resistance Ω
5	≤4.0	≥0.5	5.5	27.5x(1±10%)
6	≤4.8	≥0.6	6.6	40x(1±10%)
9	≤7.2	≥0.9	9.9	90x(1±10%)
12	≤9.6	≥1.2	13.2	160x(1±10%)
21	≤16.8	≥2.1	23.1	490x(1±10%)
24	≤19.2	≥2.4	26.4	640x(1±10%)
30	≤24.0	≥3.0	33.0	1000x(1±10%)
36	≤28.8	≥3.6	39.6	1440x(1±10%)
48	≤38.4	≥4.8	52.8	2560x(1±15%)
60	≤48.0	≥6.0	66.0	4000x(1±15%)
110 ⁴⁾	≤80.0	≥11.0	121	12250x(1±15%)
125	≤100	≥12.5	137.5	17360x(1±15%)
220	≤176	≥22.0	242	53360x(1±15%)

Nominal Voltage VAC	Pick-up Voltage VAC max. ²⁾	Drop-out Voltage VAC min. ²⁾	Max. Voltage VAC ³⁾	Coil Resistance Ω
6	≤4.8	≥1.8	6.6	11x(1±10%)
12	≤9.6	≥3.6	13.2	44x(1±10%)
24	≤19.2	≥7.2	26.4	177x(1±10%)
36	≤28.8	≥10.8	39.6	400x(1±10%)
48	≤38.4	≥14.4	52.8	708x(1±10%)
60	≤48.0	≥18.0	66.0	1100x(1±10%)
100	≤80.0	≥30.0	110	3400x(1±15%)
110 ⁴⁾	≤80.0	≥33.0	121	3400x(1±15%)
120 ⁴⁾	≤88.0	≥36.0	132	4080x(1±15%)
200	≤160	≥60.0	220	13600x(1±15%)
220 ⁴⁾	≤160	≥66.0	242	13600x(1±15%)
240 ⁴⁾	≤176	≥72.0	264	16300x(1±15%)
277	≤221.6	≥83.1	304.7	23590x(1±15%)

Notes: 1) Under ambient temperature, applying more than 80% of rating voltage to coil, relay will take action accordingly. But in order to meet the stated product performance, please apply rated voltage to coil.

2) The data shown above are initial values.

3) Maximum voltage refers to the maximum voltage which relay coil could endure in a short period of time.

4) A110: Nominal Voltage(100~110)V.a.c.;

A120: Nominal Voltage(110~120)V.a.c.;

A220: Nominal Voltage(200~220)V.a.c.;

A240: Nominal Voltage(220~240)V.a.c.;

110: Nominal Voltage(100~110)V.a.c.;

120: Nominal Voltage(110~120)V.a.c..

SAFETY APPROVAL RATINGS

UL/CUL	AgCdO	HF13F 1Z/1H	15A 250VAC
			10A 240VAC
			15A 30VDC
		HF13F 2Z/2H	10A 30VDC
			10A 250VAC
			10A 30VDC
	AgCe	HF13F 1Z/1H	15A 250VAC
			15A 30VDC
		HF13F 2Z/2H	10A 250VAC
	10A 30VDC		
	AgSnO ₂	HF13F 2Z/2H	10A 250VAC
			10A 30VDC
1/3HP,240VAC/ 120VAC			
HF13F 2Z/2H		10A 250VAC	
		10A 30VDC	
		10A 30VDC	
TÜV	AgCdO	HF13F 2Z/2H	10A 250VAC,70°C
			10A 30VDC,70°C
	AgSnO ₂	HF13F 2Z/2H	10A 250VAC,70°C
			10A 30VDC,70°C
	AgNi	HF13F 2Z/2H	10A 250VAC,70°C
			10A 30VDC,70°C

Notes: 1) All values unspecified are at room temperature.

2) Only typical loads are listed above. Other load specifications can be available upon request.

ORDERING INFORMATION

Type	HF13F / A 012 -2Z 1 3 D (XXX)
Coil voltage form	A: AC Nil: DC
Coil voltage	DC: 5VDC to 220VDC AC: 6VAC to 277VAC
Contact arrangement	1H: 1 Form A 2H: 2 Form A 1Z: 1 Form C 2Z: 2 Form C
Mounting termination ¹⁾	1: Socket 2: PCB 5: Flange-Mounting
Contact material	3: AgNi T: AgSnO G: AgCdO+Au plated 3G: AgNi+Au plated TG: AgSnO+Au plated Nil: AgCdO
LED	D: With LED Nil: Without LED J:with free wheeling diode DJ:with light emitting diode and with free wheeling diode
Special code ²⁾	XXX: Customer special requirement Nil: Standard

Notes: 1)No 1H2/1Z2 type products.

2)The customer special requirement express as special code after evaluating by Hongfa.

OUTLINE DIMENSIONS, WIRING DIAGRAM AND PC BOARD LAYOUT

Unit: mm

HF13F/i1i1i1i1i1-1Z1i1

Outline Dimensions

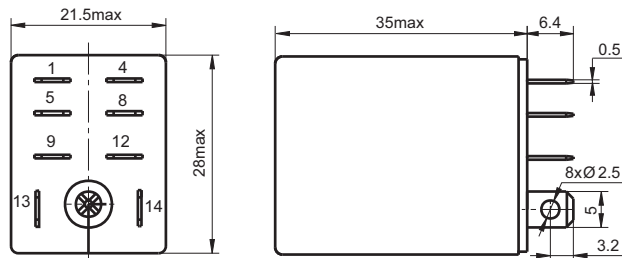

Wiring Diagram
(Bottom view)

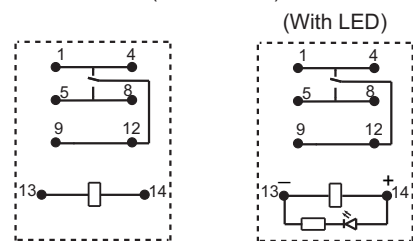

Remark: For AC parts with diode, the positive and negative pole markings on wiring diagram are not applicable.

HF13F/i1i1i1i1i1-2Z1i1

Outline Dimensions

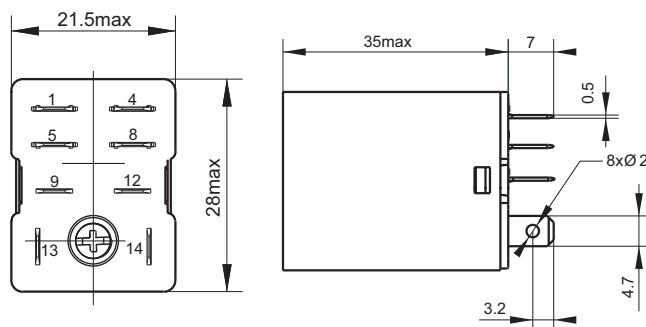

Wiring Diagram
(Bottom view)

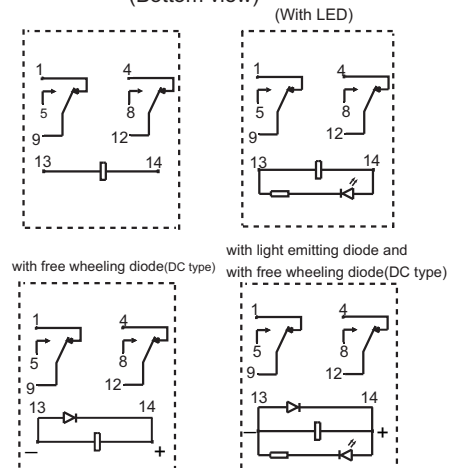

Remark: Fly-wheel diode products need to distinguish between the cathode. Only with LED products do not need to distinguish between the cathode.

OUTLINE DIMENSIONS, WIRING DIAGRAM AND PC BOARD LAYOUT

Unit: mm

HF13F/i1i1i1i1-2Z2i1

Outline Dimensions

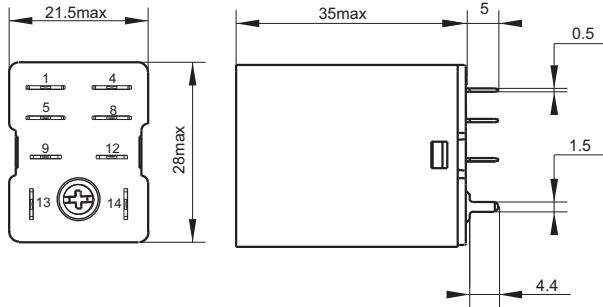

Wiring Diagram (Bottom view)

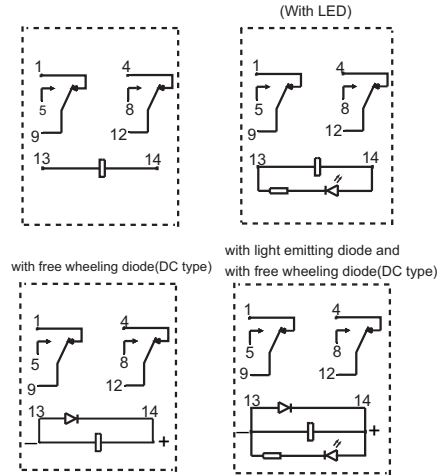

Remark: Fly-wheel diode products need to distinguish between the cathode. Only with LED products do not need to distinguish between the cathode.

PCB Layout (Bottom view)

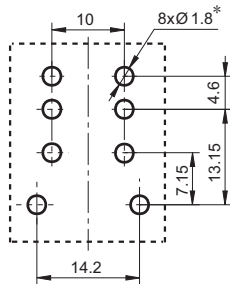

*: Please adjust the site of this diameter according to the actual application.

HF13F/i1i1i1i1-2Z5i1

Outline Dimensions

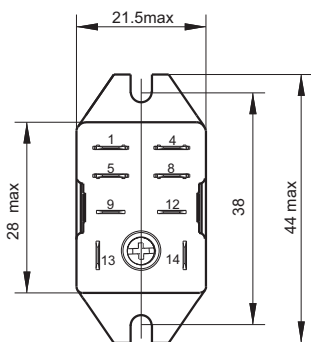

Mounting holes

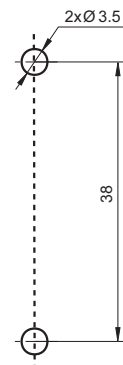

Remark: 1) In case of no tolerance shown in outline dimension: outline dimension $\leq 1\text{mm}$, tolerance should be $\pm 0.2\text{mm}$; outline dimension $> 1\text{mm}$ and $\leq 5\text{mm}$, tolerance should be $\pm 0.3\text{mm}$; outline dimension $> 5\text{mm}$, tolerance should be $\pm 0.4\text{mm}$.
2) The tolerance without indicating for PCB layout is always $\pm 0.1\text{mm}$.

CHARACTERISTIC CURVES

MAXIMUM SWITCHING POWER(1C)

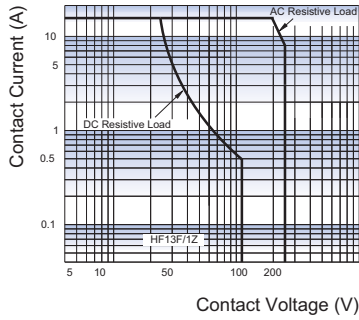

MAXIMUM SWITCHING POWER(2C)

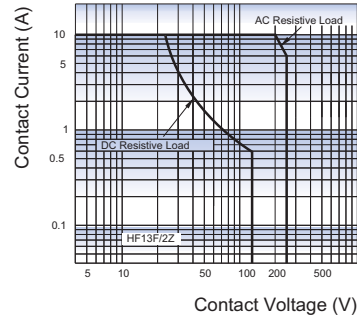

Relay Sockets



Features

- The dielectric strength can reach 2000VAC and the insulation resistance is 1000 MΩ
- Three mounting types are available: PCB mounting, screw mounting and DIN rail mounting.
- With finger protection device
- Components available: metallic retainer
- Environmental friendly product (RoHS compliant)

CHARACTERISTICS

Type	Nominal Voltage	Nominal Current	Ambient Temperature	Dielectric Strength min.	Screw Torque	Wire Strip Length	Unit weight
13F-2Z-A2	250VAC	10A/15A	-40 °C to 70 °C	2000VAC	—	—	Approx. 9g
13F-2Z-C1	250VAC	10A/15A	-40 °C to 70 °C	2000VAC	1.0N · m	7mm	Approx. 51g
13F-2Z-C2	250VAC	10A/15A	-40 °C to 70 °C	2000VAC	1.0N · m	7mm	Approx. 52g

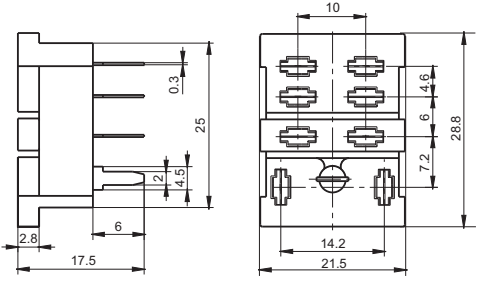
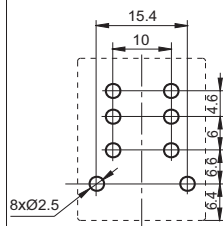

OUTLINE DIMENSIONS, WIRING DIAGRAM AND PC BOARD LAYOUT

Unit: mm

Socket	Outline Dimensions	Wiring Diagram	PCB Layout	Components Available
<p>13F-2Z-A2</p>  <p>PCB terminal, PCB mounting</p>	 <p>(Top View)</p>			<p>metallic retainer 18FF-H1</p>

OUTLINE DIMENSIONS, WIRING DIAGRAM AND PC BOARD LAYOUT

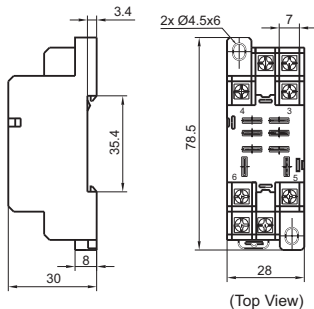
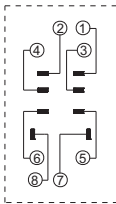
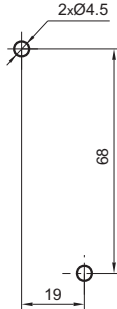
Unit: mm

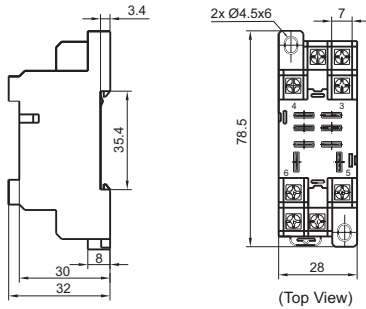
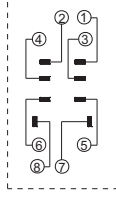
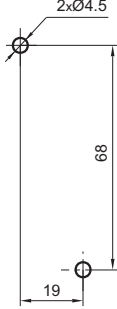
Socket	Outline Dimensions	Wiring Diagram	PCB Layout	Components Available
<p>13F-2Z-C1</p>  <p>Screw terminal, DIN rail or Screw mounting, Without finger protection device</p>	 <p>(Top View)</p>	 <p>(Top View)</p>		<p>metallic retainer 18FF-H2 (be used in sets)</p>
<p>13F-2Z-C2</p>  <p>Screw terminal, DIN rail or Screw mounting, With finger protection device</p>	 <p>(Top View)</p>	 <p>(Top View)</p>		<p>metallic retainer 18FF-H2 (be used in sets)</p>

DIMENSION OF RELATED COMPONENT (AVAILABLE)

Unit: mm

Retainer

18FF-H1 (Metallic retainer)

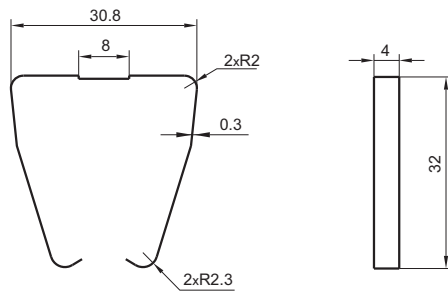

18FF-H2 (Metallic retainer)

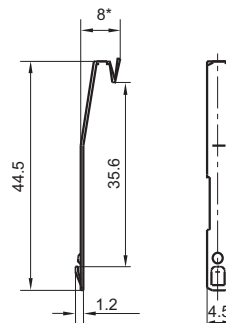

Note: 18FF-H2 retainer has to be used in sets, please pay special attention while placing the order.

Things to be noticed when selecting sockets:

1. Please choose suitable relay socket according to the actual mounting environment, relay contact poles and terminal layout. If there is any query on selection, please contact Hongfa for the technical service.
2. As for other related components, they should be selected separately. Please do give clear indication of the types of relay sockets and related components you choose while placing order.
3. The above is only an example of typical socket and related component type which is suitable to HF13F relay. If you have any special requirements, please contact us.
4. Main outline dimension (L, W, H) ≥ 50 mm, tolerance should be ± 1 mm; outline dimension > 20 mm and < 50 mm, tolerance should be ± 0.5 mm; outline dimension ≤ 20 mm, tolerance should be ± 0.3 mm.
5. DIN rail mounting: recommend to use standard rail $35 \times 7.5 \times 1$ mm, $35 \times 15 \times 1$ mm.

Disclaimer

The specification is for reference only. See to "Terminology and Guidelines" for more information. Specifications subject to change without notice. We could not evaluate all the performance and all the parameters for every possible application. Thus the user should be in a right position to choose the suitable product for their own application. If there is any query, please contact Hongfa for the technical service. However, it is the user's responsibility to determine which product should be used only.

© Xiamen Hongfa Electroacoustic Co., Ltd. All rights of Hongfa are reserved.