

Explanation To Terminology And Guidelines

Preface	302
Chapter 1 The Basic Terminology Of Relays	303
1. Contact Parameters (the output of the relays)	303
2. Characteristics Parameters	304
3. Coil Parameters (the input of the relays)	306
4. Safety Approval	306
5. Ordering Code	307
6. Outline Dimensions, Wiring Diagram And The Size Drawing Of The Mounting Holes	307
7. Characteristic Curves	307
8. Monostable, Latching And Polarized Relays	308
Chapter 2 The Principles Of Selecting The Relays ---	309
Chapter 3 Precautions For Applying The Relays	315
Chapter 4 Quick Zoom Table For Reasons For Failure	332
Chapter 5 Ordering Example	333

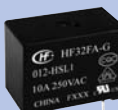
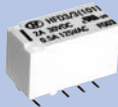

PREFACE

1. Principles

HF and its affiliates have made every effort to guarantee the accuracy of instructions and specifications. Still, errors may occur. Therefore, HF and its affiliates reserve the right to make any modification to the instructions and specifications.

HF and its affiliates claim only the responsibility of the clearly confirmed experiment clauses and condition of sale as well as the application condition and test results stated in particular specifications. We disclaim any assumptions or implications of any of our specifications and instructions.

Given the impossibility of defining all the requirements of all the relays in every application, users shall select relays accordingly and re-check through careful evaluation, or turn to HF and its affiliates for technic support if necessary. Users shall take full responsibility for relay selection.

2. Definition and Classification

Relay is a kind of component by which when the input is reached to a certain value, one or more outputs will produce the scheduled changes.

For electromagnetic relay, SSR and combined relay, it can be simply understood as the following way: it is a switch by which in the input end the speculated electrical signals are applied, the output end makes or breaks the controlled circuit.

There are many kinds of classifications about relay, we take the following classifications shown as table 1.

Table 1

Classifications		Application Fields	Advantages
Electromagnetic Relay	Signal relay	Generally for telecom and signal control	<ul style="list-style-type: none"> ● Without leakage current in the open output end ● In the large load, it is unnecessary to add the radiators
	Power relay	Generally for home application	
	Industrial relay	Generally for industrial application	
	Latching relay	Generally for power control	
	Automotive relay	For automotive fields	
	Hermetically sealed relay	For the fields where the environment is bad and the high reliability is required	
SSR & Power Module		For the fields where the environment is bad, low noise and high reliability are required.	<ul style="list-style-type: none"> ● With long electrical endurance ● Without noise ● Good shock and vibration capability
Combined Relay		For the fields where the certain control functions are required.	<ul style="list-style-type: none"> ● With certain control logic

According to the classifications of relay, our catalogue can be divided into general relay fascicule, automotive relay & module fascicule, industrial relay fascicule, latching relay fascicule and hermetically sealed relay fascicule. In general relay fascicule, power relay and signal relay are included; and in automotive relay & module fascicule, plug-in relay, PCB relay and automotive module are included. We also provide the sockets which match to the relays.

This article states the basic information about the electromagnetic relay, lists the selecting principles and cautions of applications.

Generally the parameters of the instructions in the catalogue are the measured initial values under the standard, which are as following, unless otherwise stated.

- 1) temperature: 15°C to 35°C
- 2) relative humidity: 25% to 75%
- 3) air pressure: 86kPa to 106kPa

Generally the drawing stated in the catalogue is the first quadrant projection way as shown in figure 1, unless otherwise stated.

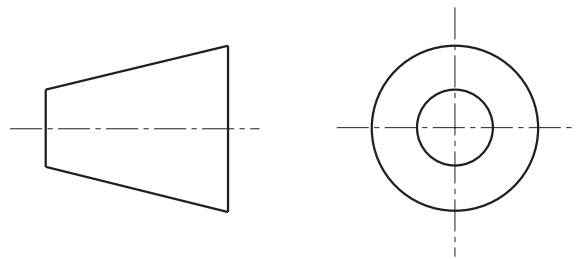

Figure 1

CHAPTER 1 THE BASIC TERMINOLOGY OF THE RELAYS

1. Contact Parameters

1.1 **Contact forms** are the arrangements of relay contacts. The basic contact arrangements are shown in Table 2, the multi-contact arrangements can be ratiocinated.

Table 2

Name	Symbol	Alphabet Letter	
		China	Others
Normally Open Contacts		H	A (or NO)
Normally Closed Contacts		D	B (or NC)
Change-Over Contacts		Z	C (or CO)



HONGFA RELAY

ISO9001, ISO/TS16949, ISO14001, OHSAS18001, IECQ QC 080000 CERTIFIED

- 1.2 Contact resistance** is the total resistance between the contacts, the terminals and spring jointed with contacts, generally shown in $m\Omega$.
Unless otherwise stated in the catalogue, generally for the relay with contact load below 2A, its contact resistance is measured in 6Vd.c., 0.1A; for the relay with contact load above 2A, its contact resistance is measured in 6Vd.c., 1A. contact resistance should be tested with the max applicable voltage and current according to the corresponding load type in IEC61810-7.
- 1.3 Contact voltage drop** generally is, in the load circuit, the total voltage drop between contacts, springs jointed with contact and the terminals. It is generally described as the voltage drop value under the regulated current, for example 50mV (measured in 10A).
- 1.4 Contact material** is the material used in contacts and generally shown in chemistry formula, for example, AgNi represents silver-nickel alloy contacts. The material used in the relay, its characteristics and its application environment can be seen in 1.2 'Contact material' in chapter 2 'the principles for selecting relays'.
- 1.5 Contact rated load** generally refers to the load of which the contacts can switch reliably under the certain regulated conditions. Generally it is shown as the combination of the voltage and the current. The loads listed in the catalogue are resistive loads, unless otherwise stated.
- 1.6 Max. switching voltage** is the maximum load voltage of which the contacts can switch. In general application, this voltage value shall not be surpassed, or the relay endurance will be reduced.
- 1.7 Max. switching current** is the maximum load current of which relay contacts can switch. In general application, this voltage value shall not be surpassed, or the relay endurance will be reduced.
- 1.8 Max. switching power** is the maximum load power of which relay contacts can switch reliably. Generally for AC it is shown in VA while for DC it is shown in W.
- 1.9 Mechanical endurance** refers to the operations that the relays without load or with load do not lead to failure under the rated voltage, normally switch in the specified, generally it is shown in operations.
- 1.10 Electrical endurance** generally refers to the operations that the relay can normally switch when the specified load is applied on the contacts and the rated voltage is applied to the coil under the conditions that the relay is placed in the certain speculated environment. Generally it is shown in operations.
- 1.11 Surge current** generally refers to the maximum transient current of which relay can endure in the specified load.
- 1.12 Min. applicable load** generally is reference value of minimum load that the relay can switch. Please perform the confirmation test with actual load before production since reference value may change according to switching frequency, environmental condition and expected contact resistance and reliability.

2. Characteristics Parameters

- 2.1 Insulation resistance** is the impedance when the conductors insulated with insulating material are applied to voltage and it is generally shown in " $M\Omega$ ". The speculated voltage discribed above are general 500Vd.c.(or 250 Vd.c.).
- 2.2 Dielectric strength** is the voltage value when, within the speculated time, the conductors insulated with insulated material are applied to the voltage and the leakage current is less than the speculated current. The certain voltage above generally is the effective value of AC voltage and unless otherwise stated, the leakage current is generally less 1mA.
- 2.3 Operation time** refers to, with the relay in the released state, the elapsed time from the initial application of power to the coil, till the closure of the normal open contacts. It does not include any bounce time, and expressed in "ms".
For the latching relays, operation time refers to, with the relay in the reset state, the elapsed time from the initial application of power to the coil, till the closure of the normal open contacts. Seen in figure 2.



HONGFA RELAY

ISO9001, ISO/TS16949, ISO14001, OHSAS18001, IECQ QC 080000 CERTIFIED

GUIDELINES OF RELAY

2.4 Release time refers to, with the relay in the operation state, the elapsed time from the initial removal of coil power till the re-close of the normal closed contacts. It does not include bounce time and expressed in "ms". Seen in figure 2.

2.5 Reset time (only for the latching relays) refers to, with the relay in the operation state, the time from the first application of power to the reset coil till the re-close of the normally closed contacts. Seen in figure 2.

2.6 Bounce time generally refers to the time from the initial close of the contacts till the complete close and generally expressed in "ms". Seen in figure 2.

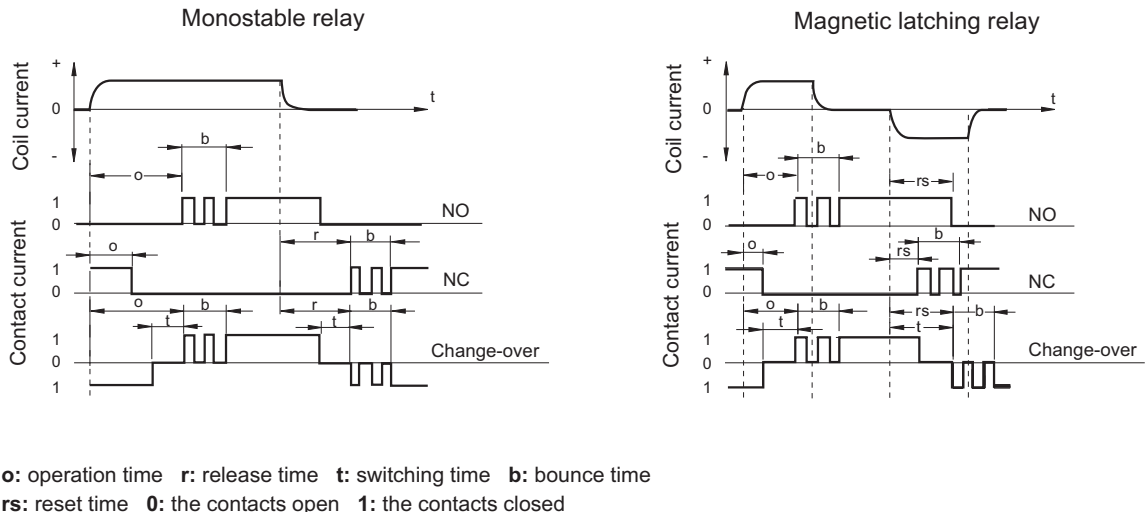

Figure 2

2.7 Switching frequency refers to the cycling times of the operation and release in united time.

2.8 Ambient temperature refers to the temperature in which the relay can normally be applied and it is generally expressed in the range of temperature.

2.9 Coil temperature rise refers to the temperature that the coil rises by after the temperature becomes stable and under the conditions that in the suitable maximum ambient environment the rated voltage is impressed on the coil and the rated load is impressed on the contacts. Generally it refers to the maximum value, expressed

2.10 Shock is divided into shock functional and survival.

Shock functional refers to the acceleration the relay can suffer the shock value under the condition of the NC contact open time and open contact closing time at specified time. Usually it is expressed in the combination of the acceleration value "g" and the duration "ms".

Shock survival refers to the shock value that can not damage the relay construction, Usually it is expressed in the combination of the acceleration value "g" ($1g=9.8m/s^2$) and the duration "ms".

2.11 Vibration resistance is divided into Vibration function and survival.

Vibration function refers to the vibration the relay can suffer without causing the closed contacts to open for more than the specified time and the open contacts to close for more than the specified time. It is usually expressed in the combination of the vibration "mm" and the vibration frequency "Hz".

Vibration survival refers to the vibration the relay can suffer without damaging their construction. It is usually expressed in the combination of the vibration "mm" and the vibration frequency "Hz".



HONGFA RELAY

ISO9001, ISO/TS16949, ISO14001, OHSAS18001, IECQ QC 080000 CERTIFIED

2.12 Humidity refers to the required humidity in which the relay can reliably work and generally expressed in relative humidity "%RH".

2.13 Model Of The Terminals

The terminals model of the relays also shows the applicable fields. Generally speaking, the models of terminals are PCB, THT, SMT, plug-in, QC and others.

2.14 Weight : the weight of the relay.

2.15 Enclosure type refers to the protection mode for the relay body. It is divided into enclosed, dust protected, flux proofed, plastic sealed and hermetically sealed. Seen in 3.1 'mode of encapsulation' in chapter 2 'the principles of selecting the relays'

3. Coil Parameters

3.1 The rated coil power refers to the power consumed by the coil when the coil are applied to the rated voltage. Generally for the DC relay, it is expressed in W while for the AC relay in VA.

3.2 Rated voltage is the voltage applied to the coil that can make relay work normally. It is expressed in "V". For the polarized relay, the direction in which the voltage is impressed should be notified.

3.3 Operate voltage is the voltage which closes the NO contacts when the relay is in the releasing state (for the latching relay in the reset state) and the coil voltage is increased gradually. Usually it is expressed in "V". It is usually the maximum value listed in the instructions, which is about 80% of rated voltage.

3.4 Release voltage is the voltage which closes the NC contacts when the relay is in the operation state and the coil voltage is gradually reduced from the rated voltage. It is usually expressed in "V". The minimum value is listed in the instructions, which is about 10% of the rated voltage.

3.5 Reset voltage is the voltage which closes the NC contacts when the latching relay is in the operation state and the reset coil voltage is increased. It is expressed in "V". The maximum value is listed in the catalogue, which is about 80% of the rated voltage.

3.6 Coil resistance generally refers to the DC resistance and is expressed in " Ω ". In the catalogue the combination of the nominal value and tolerance is given.

3.7 Maximum voltage refers to the maximum voltage which relay coil could endure in a short period of time. It is expressed in V.

4. Safety Approval

4.1 UL Approval

UL, the abbreviation of Underwriter Laboratories Inc, is a non-profitable organization founded in 1984. The electrical products authorized by this organization can be freely sold in American market, while the electrical products not authorized by this organization will be limited when they are sold in most of the states of America. Due to the authority of UL, the products approved by UL are accepted by many countries.

4.2 CSA Approval

CSA, the abbreviation of Canadian Standards Association, is the authorized approval institution. The electrical products approved by this institution can be freely sold in Canadian market. The products approved by the CSA can be only sold in Canadian market and if these products want to enter into the American market, they should get the American approval of UL.

4.3 UL&CUR

UL&CUR is the approval which simultaneously meets the American standard and the Canadian standard and can be used in North America.



HONGFA RELAY

ISO9001, ISO/TS16949, ISO14001, OHSAS18001, IECQ QC 080000 CERTIFIED

4.4 VDE Approval

VDE, the abbreviation of Verband Deutscher Elektrotechniker, is one of Germany authorized organizations in electrical component and other equipment. The electric products approved by this institution will be admitted in Germany law.

4.5 TÜV Approval

TÜV, the abbreviation of Technischer überwachungsverein, has the same authority as VDE. TÜV is one of the authorized institution in electric equipments. The electric products approved by this institution will be admitted in Germany law.

4.6 CQC Approval

CQC, the abbreviation of China Quality Certification, is the most authorized approval institution in China. The products not listed in the catalogue of 3C approval can make CQC approval in China Quality Certification Center.

5. Ordering Code

Ordering code is a code which is used to ensure the type and the specifications of the relay, which includes the basic information of relay, such as the type of the products, coil voltage, contacts arrangement, enclosure type etc.. The ordering code of HONGFA brand relay can be seen in Chapter 5 "the ordering code".

6. Outline Dimensions, Wiring Diagram And The Size Drawing Of The Mounting Holes

Ordering mark is a mark which is used to ensure the type and the specifications of the relay, which includes the basic information of the relays, such as the type of the products, the coil voltage, contacts arrangement, the mode of encapsulation etc.. The ordering marks of HONGFA brand relay can be seen in Chapter 5 "the ordering marks".

6.1 Outline dimensions describes the drawing of the relay outline size and the mounting space needed by relay.









6.2 Wiring diagram describes the wiring way of the input and output terminals respondent to the terminals of the relays.

6.3 The size drawing of the mounting holes describes the position of the relay terminals and the size of their mounting holes.

6.4 Examples

The examples of the common components can be seen in table 3.

Table 3

Coil	Polarized Coil	Contact	Resistance	Capacitance	Diode	Zener Diode	LED	Varistor
								

7. Characteristic Curves

7.1 Max. switching power curves represent the loads the relay can support.

7.2 Electrical Endurance Curve: The electrical endurance curve indicates the typical endurance under rated load. The data of all the electrical endurance do not guarantee a minimum value.

- 1) The data of all the electrical endurance are only valid for stated contact materials, special contact materials excluded. No deductions should be made from the data.
- 2) No deductions should be made from the data, especially to the situation when the current is below 0.5A as contact wear is not the dominant failure mode.

7.3 **Coil temperature rise** curve shows the measured temperature rise value of the coil when the relay is energized with different voltage and loads under the speculated ambient temperature.

8. Monostable, Latching And Polarized Relays

8.1 Monostable Relay:

For this relay, the contacts operate when the coil is energized while the contacts will reset when the coil is deenergized.

8.2 Latching Relay:

For this relay, the contacts operate when the coil is energized while the contacts will keep the state when the coil is deenergized. To reset the contacts, the counter-energization will be applied to the single-coil coil or the energization is applied to the double-coil reset coil .

8.3 Polarized Relay:

The switch of the contact state is dependent on the polarity of the energized voltage in the terminals of the coil. Part of the monostable relays and all the magnetic latching relays belong to polarized relays.

The basic circuit and operating wave of the several common relays can be seen in table 4.

Table 4

Type	The Basic Circuit And Operating Waveform		
Non-Polarized Monostable			
Polarized Monostable			
Single-coil Latching			
Two-coil Latching			

Notes: the voltage with the correct polarity is required to impress on the coil of polarized relays or the relays will not work, as shown in the shaded area in the figures above.



HONGFA RELAY

ISO9001, ISO/TS16949, ISO14001, OHSAS18001, IECQ QC 080000 CERTIFIED

CHAPTER 2 THE PRINCIPLES OF SELECTING THE RELAYS

In order to correctly select relays, customers need know the characteristics of the relays to ensure whether these characteristics meet with the practical requirements. It will be more reliable if these characteristics can be tested in the practical environment. The principles of selecting relays can be seen in table 5. In table 5, in the column "must be confirmed" the item with mark \checkmark is confirmed and a type of relay can be selected. If there is further requirement, the correspondent items with the mark \checkmark are required to be further confirmed.

Table 5

Item		The considered points	Confirmed	Reference	Influence factors
Contact	Contact load	AC, DC, size and types (inductive or resistive)	\checkmark		<ul style="list-style-type: none"> the ambient temperature as for AC load, is the operation and the load synchronous or not Does the contact material match the load?
	Contact arrangement	NO or NC or switching? how many pairs of the contacts?	\checkmark		
	Electrical endurance	The frequency and the expected operation times?	\checkmark		
	Contact material	Which material?		\checkmark	
	Contact resistance	How much and the testing conditions?		\checkmark	
Coil	Rated voltage	How much, direction, AC, DC?	\checkmark		<ul style="list-style-type: none"> the ambient temperature the power fluctuation the voltage drop driven by semi-conductor
	Coil resistance	How much? The input power consumption?	\checkmark		
	Operate voltage	How much? The influence of the power wave?		\checkmark	
	Release voltage	How much? The influence of the power fluctuation?		\checkmark	
	Max. allowable voltage	How much? How long?		\checkmark	
	Coil temperature rise	How much? Insulation level?		\checkmark	
Performance	Enclosure type	Unenclosed type, dust protected, flux proofed, or plastic sealed?	\checkmark		<ul style="list-style-type: none"> the ambient atmosphere the safety requirements
	Dielectric strength	How much? where?	\checkmark		
	Insulation resistance	How much? where?		\checkmark	
	Vibration resistance	How much? Functional or destructive?		\checkmark	
	Shock resistance	How much? Functional or strength?		\checkmark	
Practical Environment	Ambient temperature	High or low? How long?	\checkmark		<ul style="list-style-type: none"> insulation level method of encapsulation the life
	Atmosphere	Humidity? Harmful gases ?		\checkmark	
Outline And Mounting	Outline	Size and dimension	\checkmark		<ul style="list-style-type: none"> the required mounting size mounting method
	Type Of Terminals	PCB, QC, plug-in or screw fixed model?	\checkmark		
	Welding mode	Manual solder, wave solder, reflow solder ? Is cleaning needed or not?		\checkmark	
	Mounting gap	Cling or with gap?		\checkmark	
Others	Safety approval	UL、VDE、TUV、CQC etc ?		\checkmark	<ul style="list-style-type: none"> zone the customers' requirements
	Special requirements and conditions	The requirements of the customers		\checkmark	

The following will give the further explanation about the items in the table above.



HONGFA RELAY

ISO9001, ISO/TS16949, ISO14001, OHSAS18001, IECQ QC 080000 CERTIFIED

1. Contact Parameters

1.1 Contact Load

Before ensuring whether the load the relay can carry in order to meet with the application, we should confirm the type of the real load except for confirming the load value for different loads have different steady state value and inrush value. Seen in table 6. The load given in the instructions are generally the resistive load, unless otherwise stated.

Table 6

The Type Of Load	Inrush Current
Resistive Load	once steady state current
Motor Load	5-10 times steady state current
Capacitive Load	20-40 times steady state current
Transformer Load	5--15 times steady state current
Solenoid Load	10--20 times steady state current
Incandescent Lamp Load	10-15 times steady state current
Mercury Lamp Load	3 times steady state current
Sodium Vapor Lamp Load	1-3 times steady state current

Figure 3 shows the relations between the representative load and the inrush current. In addition, according to the characteristics that the polarity of different moving and stationary contacts will influence the electrical endurance. Please check in the practical application or consult the technician of HONGFA company.

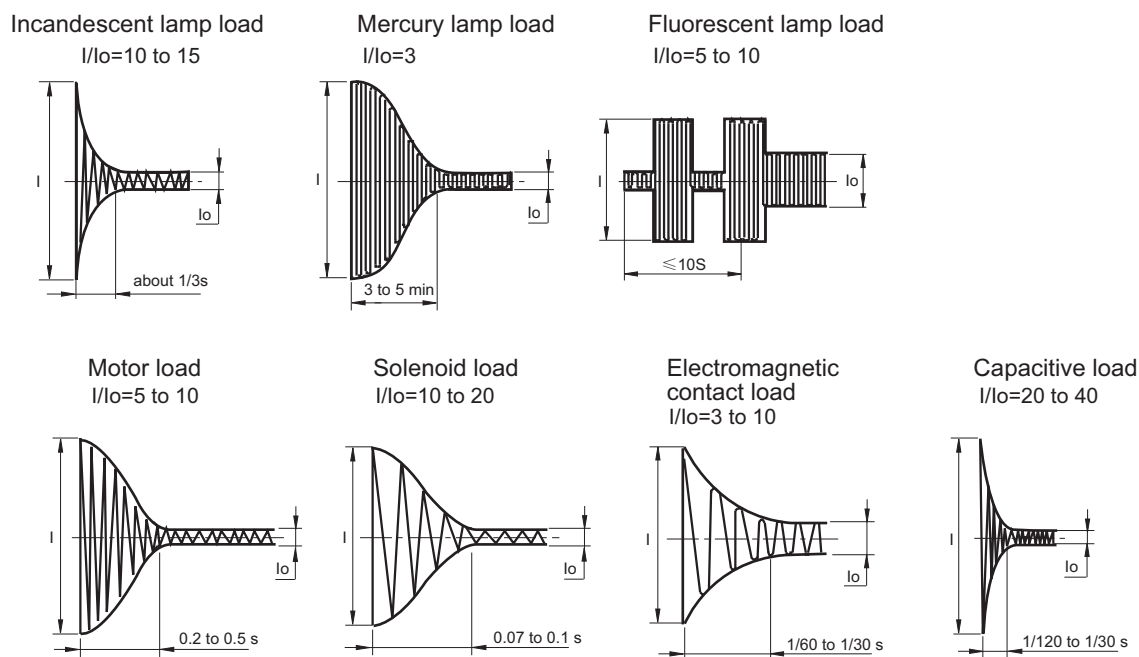

Figure 3

1.2 Contact Material

For the same type of relay, different contact materials are applicable to different load types or ranges. Seen in table 7.



HONGFA RELAY

ISO9001, ISO/TS16949, ISO14001, OHSAS18001, IECQ QC 080000 CERTIFIED

GUIDELINES OF RELAY

Table 7

Material	Feature	Typical Application
AgNi+ Au (gold plating)	<ul style="list-style-type: none"> ● gold plating with good resistance to erode in the air ● by contrast to other material, lower contact resistance and better consistency in low load ● high electrical conductivity and thermal conductivity 	<ul style="list-style-type: none"> ● Small load: gold plating almost not eroded, from 10mW(5V, 2mA) to1.5W (24V, 62.5mA) (resistive load) ● Middle load: gold plating is eroded after seve operations and AgNi functions mainly, from 2.4W (24V, 100mA) to 60W (30V, 2A) (resistive load) <p>Note: Break the low load, the typical value is 1mW (0.1V 1mA) (eg. in the testing devices); Suggest to use two pairs of the contacts in parallel.</p>
AgPd	<ul style="list-style-type: none"> ● good resistance to erode and sulfur in room temperature ● low contact resistance and good consistency ● expensive 	<ul style="list-style-type: none"> ● the same as the above
AgNi	<ul style="list-style-type: none"> ● the standard material of most contact material ● high electrical conductivity and thermal conductivity ● high resistance to burn ● average resistance to solder ● easily produce the sulfured film in the atmosphere with sulfid. 	<ul style="list-style-type: none"> ● resistive load and low inductive load ● rated current below 12A ● surge current below 25A
AgCdO	<ul style="list-style-type: none"> ● high AC load ● high electrical conductivity and thermal conductivity ● good resistance to burn ● great resistance to welding ● easily produce the sulfured film in the atmosphere with sulfid 	<ul style="list-style-type: none"> ● resistive load, motor load and inductive load ● rated current below 30A ● surge current below 30A
AgSnO ₂	<ul style="list-style-type: none"> ● great resistance to welding ● the materials transferred less than those above3 in DC load ● easily produce the sulfured film in the atmosphere with sulfid. 	<ul style="list-style-type: none"> ● lamp load, inductive load and capacitive load ● excessively high surge current load (up to 120A)
AgSnO ₂ (with other oxide matter)	<ul style="list-style-type: none"> ● the same as the above 	<ul style="list-style-type: none"> ● lamp load, inductive load and capacitive load ● excessively high surge current load (up to 120A) ● with different oxide matter, the different applicable load

Notes:

- 1) Consider the maximum current value specified in different relays.
- 2) It would be better to be checked and tested in application when the conditions are catalogue allowable.
Gold plating of the contacts shows good performance for the low loads. However, for the high load, it can only keep the initial contact performance of the contacts before the relays are used.



HONGFA RELAY

ISO9001, ISO/TS16949, ISO14001, OHSAS18001, IECQ QC 080000 CERTIFIED

1.3 Electrical Endurance

Unless otherwise specified, the electrical endurance in the instruction refers to the standard value under rated load in the circumstance that:

- a) standard condition
- b) NO contact
- c) 50Hz for AC load
- d) Make-break rate 1:9
- e) Resistive load
- f) Flux-proof
- g) Downwards PCB terminals
- h) Separated installation
- i) See severity level B according to IEC 61810-7 for failure modes
- j) See IEC 61810-7 for unstated information

Considering the flux-proof and the dust-proof types have longer electrical endurance than the sealed type of the same relay, it is preferred to select the flux-proof and the dust-proof types if possible.

1.4 Mechanical Endurance

Unless otherwise specified, the mechanical endurance in the instruction refers to the standard value under rated load in the circumstance that:

- a) no contact load
- b) Rated frequency of operation, duty factor 50%
- c) Downwards PCB terminals
- d) 50Hz for AC load
- e) See IEC 61810-7 for failure modes

2. Coil

2.1 Voltage

To make the relay work reliably, be sure that work circuit can supply the rated voltage to the coil.

In the case of transistor drive circuit, that the voltage on the coil is less than the normal voltage of the transistor drive circuit because of the voltage drop on the transistor, it is recommended to use 4.5V type relay which in 5V transistor circuit and 2.4V type relay in 3V transistor circuit.

Sometimes to shorten the operating time, the coil can be applied to maximum allowable voltage to the coil in the short time. However it should be ensured that the relay will not overheat or even be damaged.

For polarized relays, please check the polarity of the coil voltage.

2.2 Coil Resistance

To make the relay work reliably, be sure that work circuit supplies the nominal coil power consumption to the relay. Therefore please select the suitable coil resistance.

3. Performances

3.1 Enclosure Type

To ensure the reliability of the relay, different ways of encapsulation will require different post-processing(table 8).

Table 8

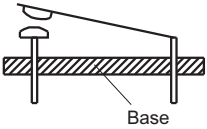
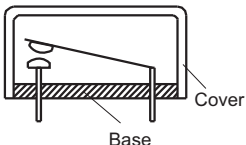
Type	Construction	Features	Auto- matic Solder	Auto- matic Clean- ing	Dust Resis- tance	Liquid Proof	Harmful Gas Resis- tance
Un- enclosed		Without the protective case	X	X	X	X	X
Dust Protected		With the dust protective case; the case and the base are fitted together and their joint is close to PCB.	X	X	√	Δ	X



HONGFA RELAY

ISO9001, ISO/TS16949, ISO14001, OHSAS18001, IECQ QC 080000 CERTIFIED

GUIDELINES OF RELAY

To be continued

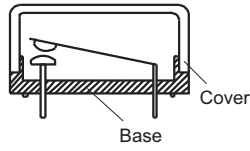
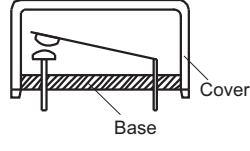
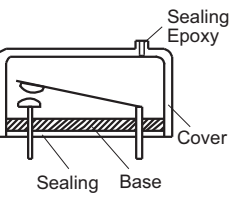
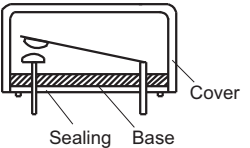
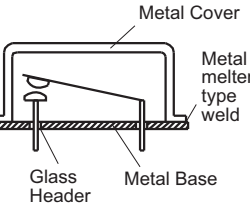
Type	Construction	Features	Auto matic solder	Auto matic clean ing	Dust resist ance	Liquid proof	Harmful Gas Resis tance
Flux Proofed		<p>With the dust protective case; the case and the base are fitted together and their joint is close to PCB.</p> <p>The terminals are plastically sealed on the base or the base and the terminals are fitted with sealing epoxy; the fitted joint is far from PCB.</p> <p>Without exceeding the scheduled position, the flux will not penetrate the relay.</p>	√	X	√	Δ	X
		<p>Without exceeding the scheduled position, the flux will not penetrate the relay.</p>					
		<p>Base, terminals and case are fitted with sealing epoxy; there is ventilating hole far from PCB.</p> <p>Without exceeding the scheduled position, the flux will not penetrate the relay.</p>	√	X	Δ	Δ	X
Plastic Sealed *		<p>Base, terminals and case are fitted with sealing epoxy; The internal of the relay is sealed in the case and base. Washable in limited condition.</p>	√	√	√	√	√
Sealed or Hermetically		<p>Metal case and metal base are sealed; terminals and base are sealed with glass.</p> <p>The leakage rate of the air in the internal of the relay meet with the requirements.</p>	√	√	√	√	√

Notes:

- 1) "√" means good; "x" means not good; "Δ" means to notify.
- 2) Because the plastic has the certain leakage, please use hermetic relays in the conditions that there are harmful gases or the explosive proof is required.
- 3) * Hongfa recommends to implement washing-free soldering process to avoid washing on relay, ultrasonic cleaning is prohibited. If water cleaning is required after the relay is assembled on PCB, it is a must that you should get contact with hongfa and specify detailed washing method, we'll help you to choose suitable product.

3.2 Dielectric Strength And Insulation Resistance

Please confirm that these two parameters can meet the application requirement and will not lead to such conditions as the breakdown of the circuit, short circuit.

3.3 Vibration Resistance And Shock Resistance

Please confirm that these two parameters can meet the application requirement and will not lead to the failure of the relay in the course of the application.

4. Temperature

4.1 Ambient Temperature

Generally speaking, when the temperature does not exceed temperature range speculated in the catalogue, the relay can normally work. When the temperature in application is higher than the temperature speculated in the instructions, please contact Hongfa to ensure whether the relay can be normally used according to the loads.

4.2 Atmosphere



HONGFA RELAY

ISO9001, ISO/TS16949, ISO14001, OHSAS18001, IECQ QC 080000 CERTIFIED

In the atmosphere with high humidity, moisture, even freezing dew and much dust, recommend to use sealed relays. Under high humidity, it would easily accelerate the rust of the relay parts and the dust easily result in the failure of the relay contacts.

In the atmosphere with organic silicon, unsealed relays shall not be used for the organic silicon will accelerate the failure of the contacts. In the atmosphere with moisture and harmful gases as H₂S、SO₂、NO₂ etc., the flux proofed and dust protected products can not be applied while the plastic sealed products can be used and tested in application.

In application, if the ambient atmosphere is better, recommend to use the dust protected and flux proofed relays for they can get the longer electric endurance than plastic sealed relays.

5. Outline And Mounting

5.1 Outline And Mounting Gap

The outline sizes of the relays usually have a certain tolerance. Therefore when the circuit and the mounting gap are designed, the design is suggested to be done according to the maximum size in the instructions.

5.2 Welding Methods

Since July 1st, 2006, the terminals of the relays produced have been lead-free. The suggested welding temperature and time are respectively 240°C to 260 °C, 2s to 5s.

If reflow solder is required, it should be confirmed the relay can be reflow soldered according to the instructions.

If you have questions, please contact Hongfa.

5.3 The Model Of The Terminals

Select the suitable shapes of the terminals and mounting methods according to the real conditions.

Table 9







Classification	PCB (THT)	(SMT)	(Plug-in)	(QC)	(Screw)
Terminals type					
Representative products	HFD27 HF115F HFKC	HFD3	HF13F HF18FF	HF105F HFV7 HF3501	HF116F-3

Table 10

Classification	PCB Mounting			Plug-in Mounting	Screwing Mounting
	THT	SMT	THT and QC		
Mounting type					
Representative products	HFD27 HF115F HFKC	HFD3	HF102F HF105F-4 HF2160	HF13F HFV7 HF18FF HF3501	HF105F-4 HF92F HF116F

6. Others

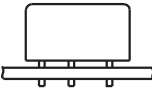
6.1 Safety Approval

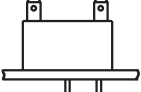
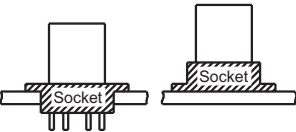
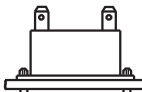
Generally UL/CUR approvals are applicable in North America and VDE&TÜV approvals are applicable in Europe. However, due to the international authority of these approvals, most of countries also accept them. If you have questions, please contact Hongfa.

6.2 Special Requirements

Except for normal products, we accept the customer's order for the products with special specifications. Please contact Hongfa when required.



HONGFA RELAY

ISO9001, ISO/TS16949, ISO14001, OHSAS18001, IECQ QC 080000 CERTIFIED

CHAPTER 3 PRECAUTIONS FOR APPLYING THE RELAY

To properly use the relay, when the relay is selected and its characteristics are learnt, the precautions for using are required to be known and ensure the reliable operation of the relay.

The following precautions will be considered in application:

- 1) The relays are used within the range of the parameters listed in the catalogue, to the extent that it is possible.
- 2) The rated load and the life are the referent values, which will be different due to the different environments, load features and types. Therefore they should be tested in the practical or stimulated application.
- 3) DC relays are controlled by rectangle wave to the extent that it is possible while the AC relays are controlled by sine wave.
- 4) To maintain the performances of relays, please do not make the relay drop or be shocked strongly. Suggest that the relays dropped not be used.
- 5) Relays are used in the ambient temperature and normal humidity and in the atmosphere with less dust and harmful gas. The harmful gases include gases with sulfur, silicon and nitrogen oxide etc.
- 6) For the latching relays, please set them in the operate or reset state before they are used. Please pay attention to polarity and pulse width when energizing on the coil
- 7) For polarized relay, please notify the polarity (+, -) of the coil voltage.
- 8) Except for the above there are other precautions. In the following they will be described one by one in the order listed in table 2.

1. Precautions For The Contacts

Contacts are the most important elements of relay construction. Contact life is influenced by contact material, voltage and current value applied to the contacts (especially the voltage and current waveforms at the time of application and release), the type of load, switching frequency, ambient atmosphere, form of contact and the contact bouncing etc. The material transfer, welding, abnormal usage and the increase in contact resistance bring about the failure of the contacts. Please pay attention to them in application.

In order to better apply the relay, please refer to the following precautions of the contacts.

1.1 The Load

The resistive load value is usually listed in the catalogue, however, which is not enough. It should be checked and tested in the practical contact circuit.

The minimum load described in the instructions is not the standard lower limit value the relay can switch reliably. The reliability of this load value is different due to differences of the ON-OFF frequency, the environment, the change of the required CR and absolute values.

1.1.1 Voltage

When the inductive circuit is switched off, there are the reverse voltage which is higher than the electrical circuit. The higher this voltage is the more the energy is. Correspondently the contact wear and material transfer also increase. Therefore notify the load type and load value the contacts of the relay control.

In the same current, DC voltage value the relay can switch reliably is much less than AC voltage value for AC current exists zero point (the point when the current is zero) and the electrical arc produced easily extinguishes. However for DC current, the electrical arc extinguishes when the contact gap is up to the certain value. Therefore the duration of the arc is longer than that in AC current and the contact wear and material transfer increases.

1.1.2 Current

When the contacts are on or off, the inrush currents will greatly influence the contacts. For example, when the load is motor load or lamp load, the higher the inrush current when the contact is on, the more the contact wear and the material transfer increase, and the more easily lead to the contact weld and not to separate. Please check in practical application.

1.2 Precautions For The Application

1.2.1 Avoiding Switching Both The Large Load And The Micro Load In The Same Relay

When switching the high load, the scattered contact material is produced, which will attach to the contacts with the low load and lead to the failure of the contacts. Therefore, please avoid the same relay switching both the high load and the low load. If it is the only choice to do against this, when mounting please place the contacts switching the little load over the contacts switching the large load. However the reliability will be influenced.



HONGFA RELAY

ISO9001, ISO/TS16949, ISO14001, OHSAS18001, IECQ QC 080000 CERTIFIED

1.2.2 Precautions For The Two Pairs Of Contacts Connected In Parallel

When the two poles of contacts are connected in parallel, the reliability will be improved but the load capacity could not, for the two poles of contacts could not be opened or closed at the same time.

1.2.3 The Problems About Phase Synchronism Of contact Operation And AC Load

If the operation of the relay contacts is synchronized with the phase of the AC power and the contacts always make or break in the high load voltage, seen in figure 4, the contact weld or material transfer will increase to lead the relay to prematurely fail. Please check whether the random phase are used in actual application. When the relay is driven by timer, micro computer etc., it will appear the power phase synchronism.

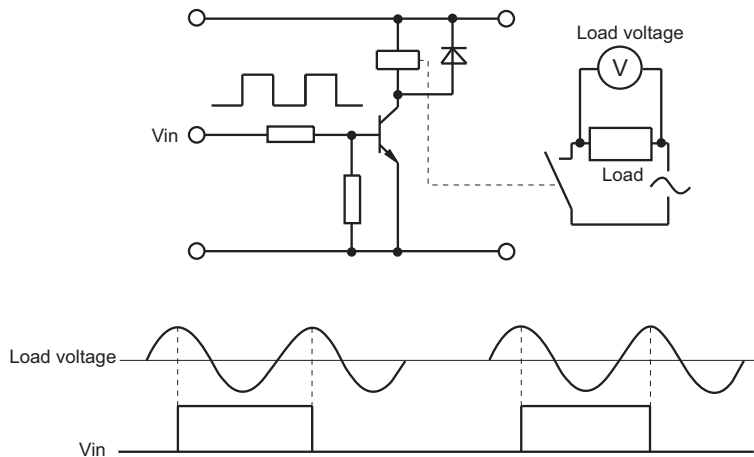

Figure 4

1.2.4 Electrical Endurance In The High Temperature

Electrical endurance of the relay will be lower in the high temperature than that in the low temperature. Please check while it is operating in the actual application.

1.2.5 Connection Of Multiple Pairs Of Contacts And The Load

Multi-contacts are arranged in the same polarity of the supply power to the extent that it is possible and the passive polarity in the other polarity of the supply power, as shown in figure 5 (a). Thus, the short circuits between the contacts, due to voltage differences between the contacts, can be possibly avoided. The wiring as shown in figure 5 (b) can be avoided.

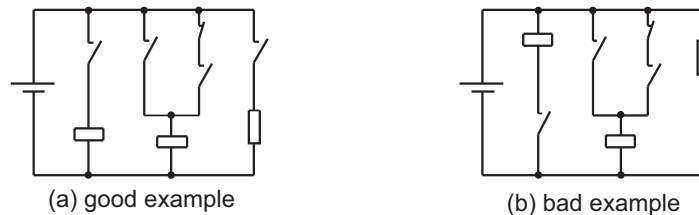

Figure 5

1.2.6 Avoid Short Circuit Caused By Contacts Weld And Electrical Arc

In the electrical circuit, the following points should be considered (seen in the figure 6)

- 1) Generally the gap between the contacts are small. The reason can probably be that the electrical arc between the contacts results in the short circuit. Please do not adopt the circuit shown in figure 6(b). The circuit shown in figure 6(a) is suggested to use and the certain interval can be set in the operation between Con1 and Con2.
- 2) It should be considered that the overcurrent should not be generated to make the circuit overload or burn when short circuit is caused by contact welding and error operation.
- 3) Care should be taken that the two pairs of switching contacts are not used to build the forward circuit and the reverse circuit, as shown in figure 6(d). Suggest that the circuit shown in Figure in 6(c) is applied and the certain interval is set in the operation between Con1 and Con2.



HONGFA RELAY

ISO9001, ISO/TS16949, ISO14001, OHSAS18001, IECQ QC 080000 CERTIFIED

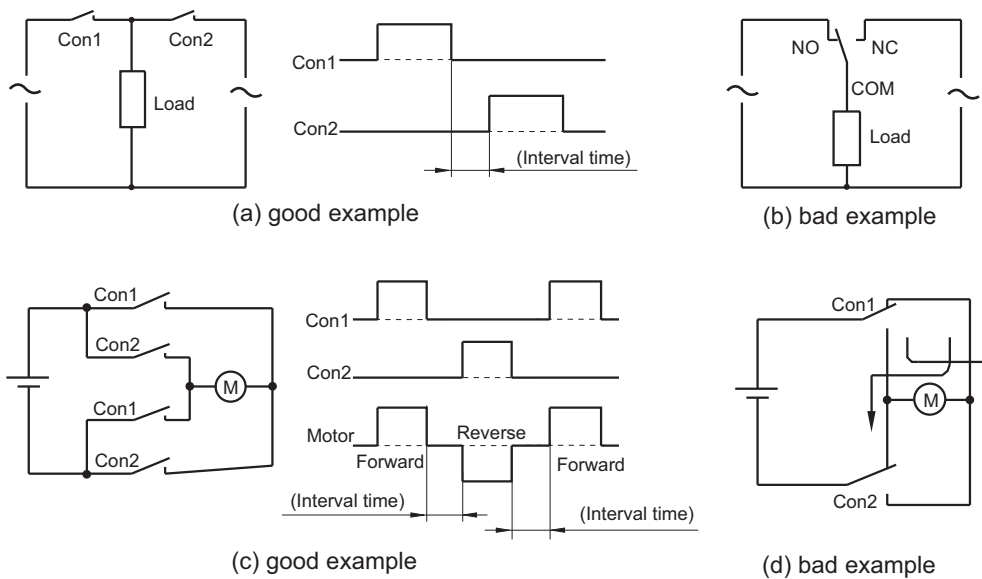

Figure 6

1.2.7 Avoid Short Circuit Between Contacts

The miniaturization of the electrical control equipments makes the control components tend to miniaturization, so the relay with multiple poles of contacts are used, care is taken of the differences of the voltage between the poles of contacts and load types. Suggest that large differences of the voltage among the contacts do not exist in order to avoid short circuit between poles of contacts.

1.2.8 Precautions For Using The Long Lead Wire

In the contact circuit of the relay, when the lead wire with more than 10m length is used, the inrush current will be generated due to the capacitance in the lead wire. Please connect in series the resistance (about 10 to 50) in the contact circuit, as shown in Figure 7.

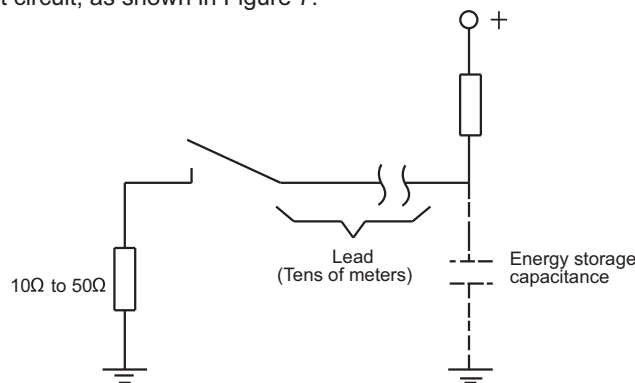

Figure 7

1.2.9 Precautions for the contacts of the magnetic latching relays

Generally the latching relays are shipped from the factory in the reset states. However during shipping or mounting relays the shock of the relay may change the operate state. Therefore suggest that in application it be set in the required state.

1.3 Contact Protection

1.3.1 Inrush Current And The Reverse Voltage

When the motor, capacitance, solenoid and lamp load make, the inrush current is generated, which is several multiple steady state currents.



HONGFA RELAY

ISO9001, ISO/TS16949, ISO14001, OHSAS18001, IECQ QC 080000 CERTIFIED

When the inductive load such as solenoid, the motor, contactor, the reverse voltage which are from hundreds of to thousands of volts. Generally in the normal temperature and atmospheric pressure the critical insulation destruction voltage of the air is 200 to 300V. Therefore if the reverse voltage exceeds this value, the discharge phenomena between contacts will happen.

Both inrush current and the reverse voltage will greatly damage the contacts and obviously shorten the relay life. Therefore the proper use of the contact protection circuit may increase the life of the relay.

1.3.2 Material Transfer Of Contacts

Material transfer of contacts refers to the transfer of the contact material from one contact to the other. When material transfer becomes serious, the accidented contact surface can be seen by eyes. As shown in figure 8, the accidented surface easily causes contact welding.

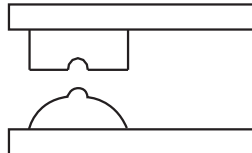

Figure 8

Generally, material transfer of contacts is caused by the one-way flowing of the large current or the inrush current of the capacitive load and often happens in DC circuit. Generally it shows the protruding shape in the passive polarity and the concave shape in the positive polarity. Therefore the proper use of the contact protection circuit or the use of AgSnO contact which has better resistance against material transfer may reduce the material transfer of contacts. The AC load with large capacity should be checked in actual application in the test.

1.3.3 The Protective Circuit Of The Contacts

Generally speaking, in contrast to resistive load, inductive load more easily damages the contacts. The use of properly protective circuit may make the influence of inductive load on the contacts equal to the influence of resistive load on the contacts. Care is taken that the incorrect use will generate the counter effect. Table 11 shows the typical examples of the contact protective circuit.

Table 11

Circuits Example	Application		Features	Device Selection
	AC	DC		
<p style="text-align: center;">CR Circuit</p>	Δ	√	<ul style="list-style-type: none"> The supply voltage is usu. 24 to 48V. The load is a timer or a contactor, the release time lengthens If the load is a time, leakage current flows through the CR circuit causing faulty operation. If used with AC voltage, be sure the impedance of the load is sufficiently smaller than that of the CR circuit. 	<p>A: As a guide in selecting C and R</p> <p>C: 0.5 to 1μF per 1A contact current</p> <p>R: 0.5 to 1Ω per 1V contact voltage</p> <p>Values vary depending on the properties of the load and variations in relay characteristics; Please check by test.</p> <p>Capacitor C acts to suppress the discharge the moment the contacts open.</p>
	√	√	<ul style="list-style-type: none"> Applicable to the supply voltage of 100 to 200V If the load is a relay or a contactor, the release time lengthens. 	<p>The dielectric strength of the capacitor C is usu. 200 to 300V or more than two times the load voltage.</p> <p>Please use AC capacitor (non polaried) in AC circuit.</p>



HONGFA RELAY

ISO9001, ISO/TS16949, ISO14001, OHSAS18001, IECQ QC 080000 CERTIFIED

GUIDELINES OF RELAY

To be continued

Circuits Example	Application		Features	Device Selection
	AC	DC		
Diode Circuit 	X	√	<ul style="list-style-type: none"> At the terminals of the inductive load the diode is connected in parallel, which can reduce the reverse voltage. The release time is longer than that in CR circuit. 	Select a diode with the reverse breakdown voltage at least 10 times the circuit voltage and a forward current at least as large as the load current. In electric circuits where the circuit voltages are not high, a diode can be used with a reverse breakdown voltage of about 2 to 3 times the supply voltage.
Diode And Zener Diode Circuit 	X	√	<ul style="list-style-type: none"> If the zener diode is added in the diode circuit the release time is reduced. 	Use a zener diode with a zener voltage about the same as the supply voltage.
Piezo Resistance Circuit 	√	√	<ul style="list-style-type: none"> Reduce the excessive high voltage between the contacts If the load is a timer and a contactor, the release time lengthens 	Use the piezo resistance with control voltage V_c 1.5 times the supply voltage peak value. If the control voltage is excessively high, the effect of the reverse control is not good. Please check in application.
Inductance Circuit 	√	√	<ul style="list-style-type: none"> Effective when piezo resistance is connected to both contacts if the supply voltage is 24V or 48V. Effective when piezo resistance is connected to the load if the supply voltage is 100V or 200V. 	
Inductance And Resistance Circuit 	√	√	<ul style="list-style-type: none"> Reduce the excessively high voltage between the contacts 	

Notes: the mark "√" means good, the mark "X" means bad, the mark "" means notice. Please avoid using the following circuit as table 12.

Table 12

When the contacts are OFF, the effect on controlling the electric arc is good. However in this case the capacitor C stores the energy, so the energy in the capacitor C will release to the contacts, when the contacts are ON, will result in the easy welding of the contacts.	When the contacts are OFF, the effect on controlling the electric arc is good. However the contacts are easily welding due to the large charge current of the capacitor C when the contacts are ON.



HONGFA RELAY

ISO9001, ISO/TS16949, ISO14001, OHSAS18001, IECQ QC 080000 CERTIFIED

1.3.4 Precaution For mounting Protective Elements

When the protective elements such as diode, C-R, piezo resistance are mounted, they must be mounted beside the load or the contacts. If the distance is far, the protective effect will not be good. Suggest to be mounted within 50cm.

2. Precautions For The Coil

The application of rated voltage to the coil is the basis for a relay to work normally. Only applied the voltage beyond the operate voltage, the relay can work, but the rated voltage must be applied to the coil for the changes caused by the temperature and the variation of the power voltage will influence the normal operation of the relay.

2.1 Types

2.1.1 AC Operation Type (AC type)

Generally the work voltage of the relay is always a commercial frequency (50Hz or 60Hz). Suggest that the products with standard voltage specifications listed in the instructions be selected to the extent that it is possible. If the products with other specifications are required, Please contact the technicians in HONGFA company.

For AC relays, due to the factors such as eddy current loss, hysteresis loss and lower coil efficiency, the temperature rise is greater than that for DC type. When voltage exceeds $\pm 10\%$ of rated voltage, the buzz is easily produced. Please notify the variation of the power voltage.

For AC relays, when the coil breaks, there should not remain any DC voltage in the circuit; otherwise the relays can not release normally.

2.1.2 DC Operation Type (DC type)

Generally the DC relays mostly are voltage drive type. Suggest that to the extent that it is impossible, the products with the standard voltages listed in the instructions should be selected. If the products with other specifications are required, Please contact the technicians.

Please check the voltage polarities of the relay coils in the instructions. If the diode for the control or the elements for displaying are added, once the opposite connection of the voltage will lead to the abnormal operation of the relays or the abnormal operation of the added elements or even short circuit. When the coil is paralled with diode or LED, the release time will be prolonged which may reduce the electrical endurance. Please note that. In addition, for polarized relay, the polarity of the voltage applied to the coil is opposite to that in the instruction, the relay will not work.

2.2 Input Power Of The Coil

2.2.1 Input Power For AC Coil

To make the relay work reliably, please apply rated voltage to the coil. If the voltage, which does not make the relay completely operate, is continuously applied to the coil, the coil will abnormally heat to make the coil abnormal wear.

The supply voltage of AC relay would better be sine curve. The AC coil can better control the buzz. If the waveform distorts or deforms, the control function can not be displayed better. Figure 9 shows several examples of common waveforms.

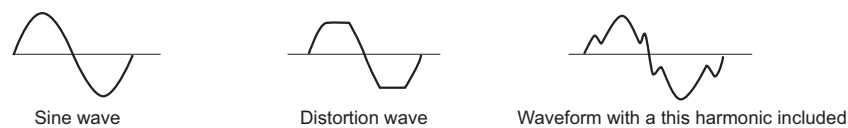

Figure 9

If the parts such as the motor, solenoid and transformer are connected in the drive circuit of the relay, when the parts work the coil voltage of the relay will reduce and then the relay contacts will shake to cause the contact welding, abnormal wear or non-conduction. The alike phenomena of the reduction of the coil voltage will happen when the miniature transformer are used, no transformer with rich capacity can be used as the power source and the wiring is long, the wiring used in the house or the shop etc. is thin. If the similar failure happens, Please use the synchro oscilloscope to check and properly adjust.

If using the loads with large variation such as the motor, Please separate the drive circuit of the coil from the power circuit according to the usage.

If the AC relay could not work reliably, switch AC to DC and then select the proper DC relay.

2.2.2 Input Power For DC Coil

In order to work steadily, the voltage applied to the two terminals of the coil of the DC relay is suggested to use



HONGFA RELAY

ISO9001, ISO/TS16949, ISO14001, OHSAS18001, IECQ QC 080000 CERTIFIED

the coil rated voltage under ±5% or the relay could not work steadily, to cause the contact welding or abnormal wear, especially when such parts as the motor, solenoid or transformer etc. are connected in the drive circuit of the relay, the case will be more obvious

As the power source of DC relay, there are the accumulator, the full(as shown in 10) or half wave rectifier circuit of smoothing capacitor, which will influence the operating characteristics of the relays. Please check in the practical application.

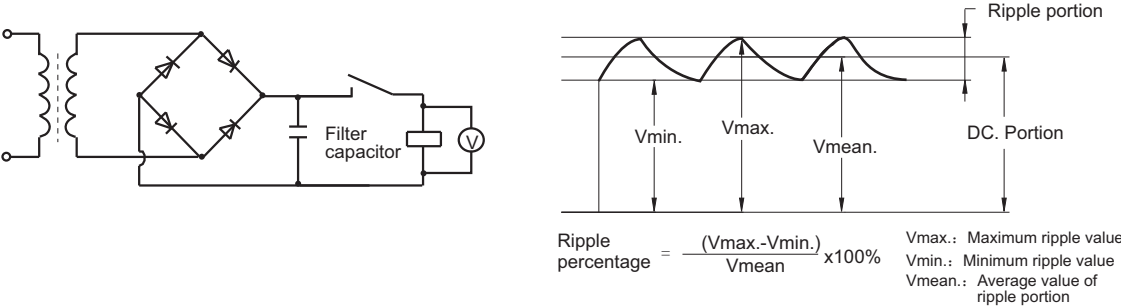

Figure 10

2.3 Maximum Voltage Of The Coil

Except for the limits from the coil temperature rise and the heat-resistant temperature of insulation material of the coil electro-magnetic wire (once beyond the heat-resistant temperature, short circuit will locally happen in the coil and even the coil burns), the maximum voltage of the coil will be influenced by heat distortion and the aging of the insulation materials. Especially it can not destroy other machines, hurt the human body or cause the fire, so it must be limited with the certain range. Therefore please do not make it beyond the regulated value in the instructions.

Maximum voltage is the maximum value of the voltage which can be applied to the coil of the relay in short time rather than the value of the voltage allowed to be continuously applied with.

2.4 The Coil Temperature Rise

2.4.1 Temperature Rise

In the course of the relay operation, the coil temperature will be increased. When a pulse voltage with ON time of less than 2 minutes is used, the coil temperature rise value is related to the ON time and the ratio of ON time to OFF time. The various relays are essentially the same in this aspect.(table 13)

Table 13

(Current Passage Time)	(%)
For Continuous Passage	Temperature Rise Value Is 100%
ON:OFF=3:1	about 80%
ON:OFF=1:1	about 50%
ON:OFF=1:3	about 35%

2.4.2 Pick-up Voltage Change Due To Coil Temperature Rise

The temperature rise causes the increase of the coil resistance and correspondently the pick-up voltage will increase. the resistance temperature coefficient of the copper wire is about 0.4% per 1°C . with this ratio, the coil resistance increases. Pick-up, release and reset voltages in the instructions are all the values in 23°C .

When the coil temperature is beyond 23°C ,pick-up voltage surpasses sometimes the speculated value in the catalogue. Please check in the practical application.

2.5 Leakage Current

When designing the circuit, please avoid the leakage current flowing through the relay when the relay does not work.

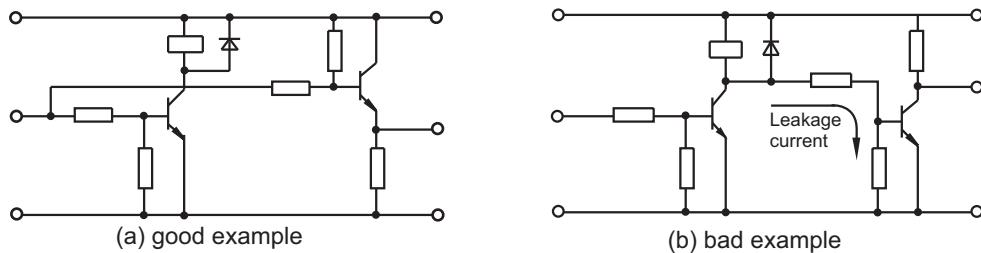

Figure 11

2.6 Energized Voltage Of The Coil And Operation Time

In the case of AC operation, there is extensive variation in operate time according to the difference of the phase when the coil is applied with the voltage.

In the case of the DC operation, although the voltage applied to the coil increases and operate time of the relay will properly become rapid, the contact bounce time when the contacts closes is extended to cause the reduction of the life or the contacts welding when they work in the rated load or in the large inrush current.

2.7 The Application Of The Relays Connected In Parallel And In Series.

Several relays connected in parallel, please take care of the wrong operation for the bypass current and leakage current shown as figure 12.

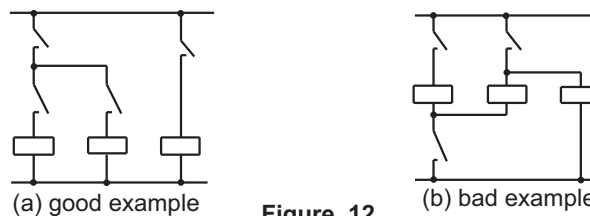

Figure 12

2.8 Avoid Gradual Increase Of Coil Impressed Voltage

In the course of the operation, the relay experiences such phases as contact pressure changing, contact bounce and the unstable condition of the contacts. When gradual increase of coil impressed voltage happens, the time of the unstable phase becomes longer to affect the life of the relay.

In order to reduce the influence on the relay, please impress bypass voltage to the coil, to the extent that it is possible.

2.9 Precaution For The Long Power Wire

If the power wire is longer, please select the relay according to the principles of impressing the rated voltage after testing the coil voltage of the relay.

If paralleled with the power line and long distance, when the supply power of the coil is switched, the voltage at the terminals of the coil will be generated due to the capacitance stored in the wire and then result in the release worse. In this case, Please connect the bypass resistor at the two ends of the coil.

2.10 Long Term Current Carrying

If the coil is continuously applied the power to for a long term, the self heating of the coil promotes the aging of the insulation materials of the coil and the worse characteristics, so in this case please use the latching relay. If the monostable relay must be used, please use the hermetic relay which is not easily influenced by the external environments and also use the suitably protective circuit to prevent the loss due to the contact failure or the break of the coil wire.

2.11 Low ON-OFF Frequency

When the ON-OFF frequency is below once per month, please periodically check the states of the contacts. If the contacts keep the non ON-OFF state for a long time, the organic film will be formed on the surface of the contacts and result in the contact failure.

2.12 Electrolytic Corrosion Of Coils

When the relays are placed in high temperature and high humidity atmospheres or with continuous passage of current, that the coil is grounded will make the coil electrolytic erosion to cause the break of the electro-magnetic wires. Therefore please do not make the coil grounded to the extent that it is possible. In the case where unavoidably the coil is grounded, please set the control switch of the relay coil in the positive side of the coil.



HONGFA RELAY

ISO9001, ISO/TS16949, ISO14001, OHSAS18001, IECQ QC 080000 CERTIFIED

2.13 Precaution For The Coil Of The Magnetic Latching Relays

2.13.1 The Coil Voltage

Please check whether the direction of coil impressed voltage is correct or not, or the relay may not work. Due to the characteristics of the magnetic latching relays, to prevent the relay against overheating and then burning, the long-term impressed voltage on the coil are not allowable.

2.13.2 Self-locking Of The Relays

Please avoid using the NC contacts of the relay itself to switch off its own coil. Otherwise the failure will happen

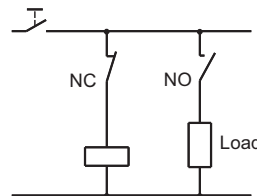

Figure 13

2.13.3 Precautions For Using The Relays Connected In Parallel

When the coil of the latching relay is connected in parallel with the coil and the solenoid of other relays, please add diode to prevent the reverse voltage from influencing the normal work of the relay.

2.13.4 Width Of Minimum Impulse In Operating And Resetting

In order to make the latching relay operate or reset, please impress the rectangle rated voltage for more than 5 times at the operate time or the reset time on the coil and then operate it. If the impulse width can not meet the requirements above, please check in the actual application.

Please avoid using in the conditions that the power source has many surges.

2.13.5 Precautions For The Double-Coil Relay

Do not impress the voltage on the set coil and reset coil at the same time, or the relay will abnormally heat, abnormally operate and even abnormally wear.

As shown in figure 14, when the terminals of either of operate coil and reset coil in the circuit are required to connect and the other terminals are connected to the same polarity of the power source, Please directly connect the terminals to connect (short circuit) and then connect to the power source. Thus the insulation between the coils can be maintained well.

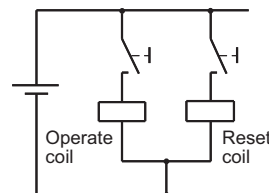

Figure 14

2.13.6 The Drive Circuit Of The Latching Single-Coil Relay

As shown in figure 15, it is one of the drive circuits of the latching single-coil relay. When the signals are input, the current charges the capacitance C and in turn charges the coil and then make the relay operate; when the signals are removed, the electric power stored in the capacitance C will discharge through trinode Tr and the coil and make the relay reset.

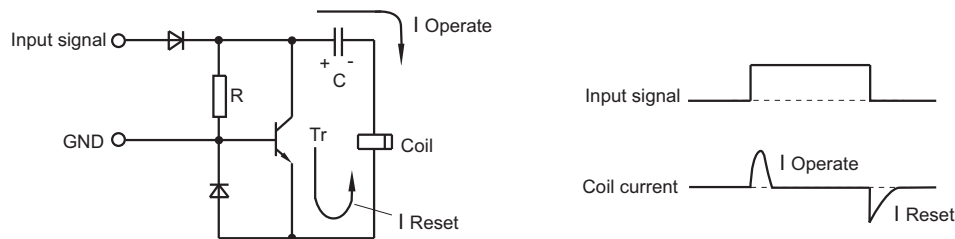

Figure 15



3. Performance

3.1 Precautions For Plastic Sealed Relays

Hermetic relays can resist under bad surrounding. However, please pay attention to the following precautions in application to avoid the failure.

3.1.1. Regarding Practical Environment

Plastic sealed relays are not suitable for using in the environment which has the special requirement for the air seal. Please avoid using them in the pressure exceeding 86kPa to 106kPa.

3.1.2. Regarding washing

When washing PC board after the terminals soldered on PC board, suggest that the washing can be done by washing solvent of alcohol series.

Please avoid supersonic washing for supersonic washing may cause the break of the coil wire and the light contact welding.

3.2 Vibration And Shock

The transient break of the contacts when the relays are shocked strongly, will lead to the false operation. Therefore, when the relays are mounted on the same board with other parts (such as electromagnetic switch, air switch et.) which can produce the shock, the measures of reducing the influence of the shock on the relay should be taken. For example, make the direction of the shock and direction of relay contacts make/break at the right angles to the moving direction of armature, or to mount these components on different boards, or using a buffer tablet, or to take some measures in the application circuit to reduce the impact of false operation of relay contacts (as illustrated by figure 16):

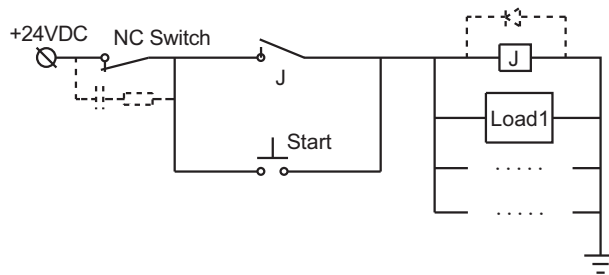

Figure 16

Remarks: in the above figure, a RC is parallel connected to NC switch, and a FWD is parallel connected to relay coil. This measure can avoid the abnormal cut-off of the circuit caused by the abrupt break of NC switch under strong shock and vibration.

In addition, for the relay in the vibration atmosphere in the long term (such as electrical car), please avoid combining with the socket in application. Suggest that the relay be directly soldered on the PC board.

3.3 The Influence Of External Magnetic Fields

If there is the strong magnetic fields around the relay, if the relay is mounted beside the large relay, transformer or the speaker, the characteristics will produce the false operation with the variation of the external magnetic fields, especially for polarized relays. Because the operation of the relay is dependent on the internal permanent magnet, it is easily influenced by the external magnetic fields. Please pay attention to the mounting position in practical application and check.

3.4 Vibration, Shock And Weight During Shipping

During shipping the relay or the equipment with the relay installed, the large vibration, shock and weight will cause the failure of the relay functions. Please use the cushion package to control the vibration and shock within the allowable range.



HONGFA RELAY

ISO9001, ISO/TS16949, ISO14001, OHSAS18001, IECQ QC 080000 CERTIFIED

4. Environments

4.1 Regarding Ambient Temperature And Atmosphere

Care is taken that the ambient temperature at the installation does not exceed the value listed in the instructions. In addition, the contact surface will form sulfured film, oxide film or attached dust in an atmosphere with dust, moisture and sulfur gases (SO₂, H₂S etc.) or organic gases to cause the unstable contact and the failure of the contacts. Therefore please select sealed relays. If the plastic sealed relay is selected, it is required to check in application.

4.2 The Harmful Gases To The Relay

Please do not use the relay in the atmosphere with the following gases. In these atmospheres, plastic sealed relays can not avoid the influence of gases on the contacts. Please use the hermetic relays.

4.2.1 Silicon Atmosphere

Silicon-based substances (silicon rubber, silicon oil, silicon-based coating material and silicon caulking compound etc.) around the relay will emit volatile silicon gas, which may cause the silicon to adhere to the contacts and may result in contact failure.

4.2.2 Sulfureted Gas

Sulfured gases easily sulfur the contacts and result in the contact failure or non-conduction.

4.2.3 NO_x Gas

When a relay is used in an atmosphere high in humidity to switch a load which easily produces an arc, the NO_x created by the arc and the water absorbed from outside the relay combine to produce nitric acid. This corrodes the internal metal parts and adversely affects operation. Please do not use the relay in the atmosphere where the humidity is beyond 85%RH (at 20°C).

4.3 The Circumstance With Water, Leechdom, Solvent And Oil

Do not use and store the relays in the atmosphere where the relays may be attached to by water, leechdom, solvent and oil etc. for water and leechdom may make the parts rusted, the plastics aging and also result in leakage current which damages the relays or the circuit and solvent and oil may make the marks disappearing or the parts aging. For covers made from PC materials, please prevent from contamination by some organic solvents; otherwise it is likely to lead to bulging or crack.

4.4 Atmosphere Of Usage, Storage And Transport

During usage, storage and transportation, avoid locations subject to direct sunlight and maintain normal temperature, humidity and pressure conditions. The allowable range of the temperature and humidity suitable for usage, storage and transportation are shown in the unshaded part in figure 17. The allowable temperature may differ with the types of the relays. In case that the condition in real application is different from that of IEC 61810-1, UL508, UL60947-4-1, GB/T21711.1, etc. the electrical endurance of the relay must be confirmed by tests.

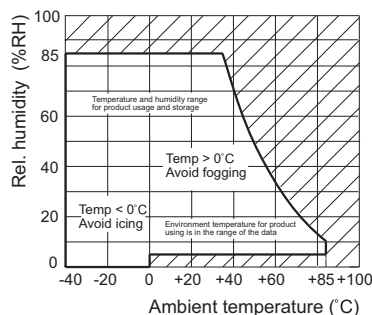

Figure 17

The suggested ranges of the temperature and humidity during usage, transportation and storage are as follows.

- 1) temperature: 0°C to 40°C
- 2) humidity: 5%RH to 85%RH
- 3) air pressure: 86kPa to 106kPa.



HONGFA RELAY

ISO9001, ISO/TS16949, ISO14001, OHSAS18001, IECQ QC 080000 CERTIFIED

4.4.1 The Atmosphere High In Humidity

In the atmosphere high in humidity, when the temperature around sharply changes, the dew will be formed in the internal of the relay and result in the cracking of the insulation material, the break of the coil wire and the rust. The typical examples will happen on the ship transporting on the sea.

Dewing is a phenomena that the vapor freezes water drops in the atmosphere high in temperature when the temperature sharply reduces from the high temperature to the low temperature or the relay is moved in the high temperature from the low temperature

4.4.2 Low Temperature (under 0°C) Environment

Please note the icing phenomena in the environment with low temperature (under 0°C). Icing may result in the welding of the movable parts, the delay of the operation or preventing the operation etc.

Icing refer to the phenomena that water attached to the relay will freeze ice when the temperature reducing below freezing point.

4.4.3 Low Temperature , Low Humidity Environment

Note that the plastics may embrittle in low temperature, low humidity environment.

4.4.4 High Temperature, High Humidity Environment

Note that if the relay is in high temperature, high humidity environment for a long time the contact surface easily forms the oxidized film and then results in the unstable contact and the failure of the contacts. Other metal parts also are easily oxidized or rusted to result in the failure of the functions

4.4.5 SMT Environment

The relay of SMT type is sensitive to the humidity so they are packed with humidity proof package. The following points should be considered during storage.

1) Please use the humidity proof packing bags as soon as possible after they are unsealed.

2) If the humidity proof packing bags need long term storage after they are unsealed, it is suggested that the desiccator with humidity control be used to store them.

5. Outline And Mounting

5.1 Top View And Bottom View

Generally the bottom view is the projection whose projection plane is terminal side. Otherwise, the top view is the projection whose projection plane is cover side. Please take care of it when using the instructions or mounting the relays.

5.2 Mounting Direction

Unless otherwise stated, mounting direction of the relays is arbitrary. In order that the relay can work more stable and reliable, mounting direction need cosidering.

5.2.1 Vibration Resistance And Shock Resistance

It is ideal to mount the relay so that the movement of the contacts and movable parts is perpendicular to the direction of vibration or shock. Especially when the coil is not excited, the vibration or shock resistance of NC contacts is weak. If mounting direction is proper, their functions can be ensured.(figure 18)

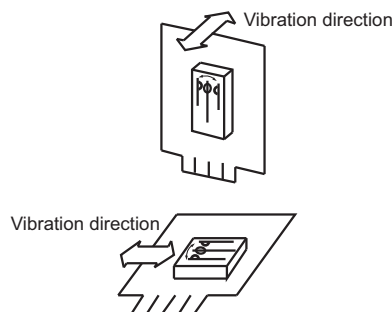

Figure 18



HONGFA RELAY

ISO9001, ISO/TS16949, ISO14001, OHSAS18001, IECQ QC 080000 CERTIFIED

5.2.2 Contact Reliability

Mounting the relay so the surfaces of its contacts are vertical prevents dirt and dust as well as scattered contact material and powdered metal from adhering to them when the arc is generated.

5.3 Adjacent Mounting

When many relays are mounted close together, abnormally high temperatures may result from the combined heat generated. To prevent the heat buildup, please mount relays with sufficient spacing between them. When many boards mounted with relays are installed in a card rack, please be sure that the ambient temperature of the relay does not exceed the value listed in the instructions.

5.4 Shroud Mounting

Use the gaskets when mounting to prevent from the damages and deforms. Keep the screwing moment in the range of 0.49 to 0.686N · m (5 to 7kgf·cm. To prevent from loosening, please use the spring gasket.

5.5 Mounting The Plug-In Terminals

When mounting the relay with plug-in terminals, the plug-in strength is based on 40N to 70N (4kgf to 7kgf).

5.6 Supersonic Cleaning

Do not clean the relay by the way supersonic cleaning, for the supersonic will result in the contact welding and the break of the coil wire.

5.7 Mounting And Soldering Of THT Relays

The mounting and soldering of the THT relay can be divided into the following steps.(figure 19)

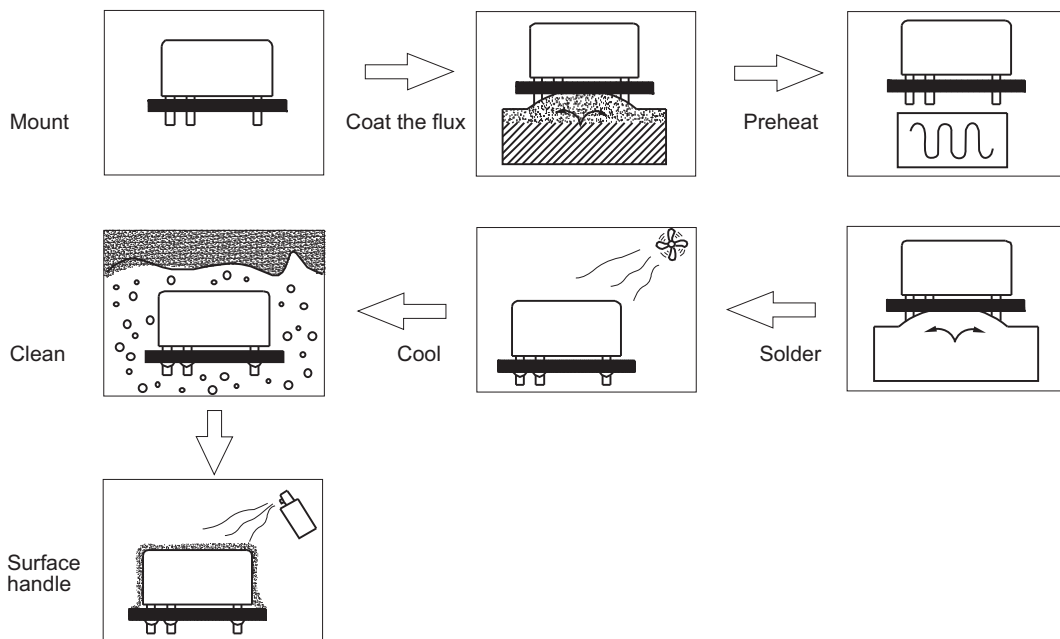

Figure 19

In the following the considered points are described when THT relay is soldered on the PC board. Please refer to them in application.

Note that if the solder entered the relay due to the carelessness, the functions of relay will be destroyed. There will be such problems as the relay not be suitable for the automatic soldering or cleaning due to the different protective constructions. Please see the details in the constructions and characteristics in 3.1 pattern of encapsulation in Chapter 2.



HONGFA RELAY

ISO9001, ISO/TS16949, ISO14001, OHSAS18001, IECQ QC 080000 CERTIFIED

5.7.1 Mounting

Do not bend the terminals of the relay (figure 20) for it may destroy the initial performances of the relay. Please correctly process the PC board according to the mounting hole drawing in the instructions. Please maintain the balance of the relay. Please note that the set force of the hook for mounting is too much large to result in the internal failure of the relay.

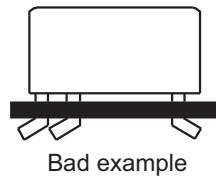

Figure 20

5.7.2 Coating Flux

Please use the rosin flux which is not corrosive and the alcohol solvent which is less chemistry. Please use the thin and even coating flux to prevent from penetrating the relay. As for the dipping coating, please keep the surface of the flux stable. Please adjust the places to ensure that the flux will not overflow through the surface of PCB. Please do not make the flux attached to the parts of the relay except for the terminals. Otherwise the insulation of the relays will be reduced. For the dust protected relays and flux proofed relays, do not use the coating method of pushing deeply PCB from the above into the sponge absorbing the flux, as shown in figure 21. This will make the flux penetrating the relay, especially for the dust protective type.

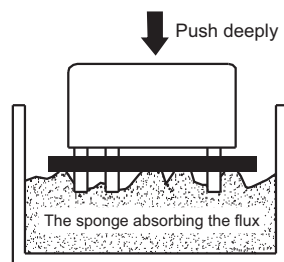

Figure 21

5.7.3 Preheating

In order to improve the soldering performance, please preheat without failure. Please preheat under 100°C (the soldered surface of the PC board) within 1 minute. Do not use the relays which are placed in the high temperature for a long time due to the set failure for their initial performance may have changed.

5.7.4 Soldering

Precautions for soldering seen in table 14.

Table 14

Automatic Soldering	Manual Soldering
<ul style="list-style-type: none"> To maintain the soldering stable, the suggested soldering method is wave solder. Adjust the height of flux liquid level to make them not overflow the PCB. Please do it according to following suggested conditions. Soldering temperature: about 260°C ± 5°C (Applicable to Power relays) Soldering temperature: about 250°C ± 5°C (Applicable to Signal relays) Soldering time: within about 5s. 	<ul style="list-style-type: none"> Please sufficiently clean the head of searing-iron with fluxing to make the surface of it smooth. Please do it according to the following suggested conditions. Searing-iron: 30W or 60W The temperature of the head of searing-iron: about 280°C or 300°C Soldering time: within about 3s Use the solder with rosin fluxing.



- Remarks:
1. The preheating and soldering temperature and time for automatic soldering should be reduced as low as possible to avoid any change in relay performance due to excessively high temperature or too long time preheating or soldering.
 2. It is normal if some relay covers become slightly bulging under right soldering conditions.
 3. In the process of manual soldering it is prohibited to press or pull the relay terminals because such doing will lead to changes in product performance or even relay failures.

5.7.5 Cooling

After automatic soldering, please ventilate and cool them to avoid the aging of the relay or its parts caused by the heat generated when the relay soldered.
Although the sealed relay can be cleaned, it is not cleaned for the sudden connection with the cool solvent may damage the hermetic characteristics of the relay.

5.7.6 Cleaning

Please select the cleaning method in table 15 when cleaning.

Table 15

Dust Protected Type	Flux Proofed Type	Plastic Sealed Type
<ul style="list-style-type: none"> ● Hot cleaning or soap cleaning not allowable ● Scrub the welding surface of PCB 		<ul style="list-style-type: none"> ● Washable in limited condition. ● Use the alcohol solvent or water. ● The temperature for cleaning is under 40°C. ● Do not do supersonic cleaning or truncate the terminals of the relays, or the break of the coil wire and the contact welding will happen.

Due to different soldering condition, sealed relays can be impaired when mounting on PCB. If cleaning is necessary after soldering, it is recommended to solder under the condition provided by HF and to select special sealed relays (customer code: 310).

Avoid cleaning with Freon, Trichloroethane, diluent or gasoline.

5.7.7 Surface Handling

In order to prevent the insulation of PCB from worsening, Please note the following precautions when surface handling.

The dust protected type and the flux proofed type result in the failure due to the surface handling agents penetrating the relay. Therefore please do not do the surface handling or mount the relay after surface handling.

Due to the bad influence of the surface handling agents on the relay eg. melting the cover, please select carefully and check and test in application.

Spraying and brushing processes are recommended for surface treatment, and dip-coating is prohibited. Surface treatment agent should best be room-temperature liquid agent, which should be sprayed when the relay is cooled down to room-temperature. The agent can be dried naturally or under constant temperature which should not exceed 60°C. Meanwhile, the drying temperature is not allowed to be decreased when the agent is not completely dried, otherwise the agent could be absorbed into the relay and thus lead to relay failure.

Please contact us when special surface treatments processes are used so that we can provide you a suitable product.

There are the following suggestions on the coat, as shown in table 16.

Table 16

Type Of The Coat	Plastic Sealed Relay
Epoxy resin	Allowable
Polyurethane	Allowable
Silicon	Not allowable
Fluorin	Allowable



HONGFA RELAY

ISO9001, ISO/TS16949, ISO14001, OHSAS18001, IECQ QC 080000 CERTIFIED

5.8 Mounting And Soldering Of SMT Relays.

The mounting and soldering of SMT relays have the following steps, as shown in figure 22. In the following the considered points are listed when the SMT relays are soldered on PCB.

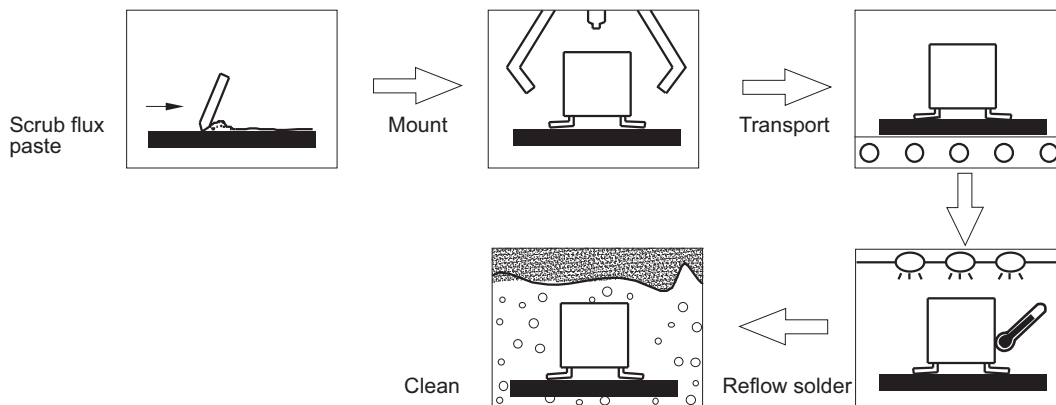

Figure 22

Please refer to these in application. Note that the relays are not damaged in processing.

5.8.1 Scrub Flux Paste

Please use the rosin and chlorine-free flux paste for chlorine may erode the terminals and circuit panel. Flux paste should be coated evenly and the thickness is 0.15mm or 0.2mm.

5.8.2 Mounting

When mounting the relays, do not set the conservative force of the finger within the range specified in table 17, unless otherwise stated in the catalogue.

Direction	Maintaining Force	
Birection A	Below 1.96N	
Birection B	Below 4.9N	
Birection C	Below 1.96N	

5.8.3 Transportation

During the transport, the relays will not fall off due to the factors such as the shock and vibration to avoid the bad soldering produced thereby.

5.8.4 Reflow Solder

Figure 23 shows the temperature curve of the PCB surface when the infrared ray are used to reflow solder. Please consult the specification of the relays due to the different characteristics of the different relays. If there is no statement in the instructions, Please use the temperature curve as shown in the following figure.

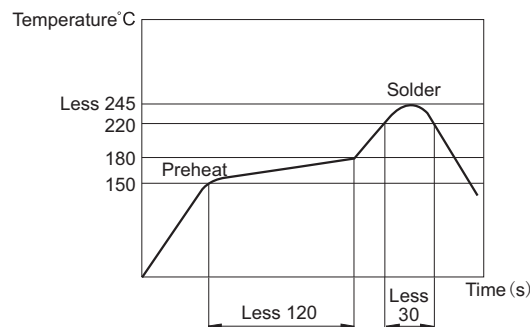

Figure 23



When just finishing soldering, please do not clean the relay immediately, for the connection with the cool solvent may damage the hermetic characteristics of the internal parts.
Do not dip the relay in the flux groove for it will deform the plastics and then result in the failure of the relays.
Please see the soldered state in figure 24.

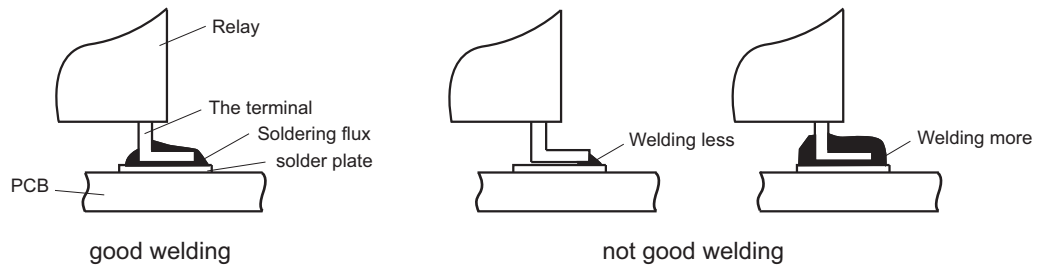

Figure 24

5.8.5 Cleaning

Hot cleaning or soap cleaning can be used and the cleaning temperature should be controlled under 40°C.
Please use the alcohol solvent or water to clean and do not use Freon, thinner or gasoline to clean.
Do not use supersonic to clean, or the break of the coil wire and the contact welding will be resulted in.
Improper welding will decrease the relay sealing, so please do not clean the relay or do the surface treating (soaking prtector).

6. Other Precautions

6.1 Precautions For The Safety

When the relay works, do not touch the relay with hands for there is the danger of getting the electric shock.
Please switch off the power when mounting, maintaining and handling the relays (including the connecting parts such as terminals and sockets).
When connecting the terminals, firstly refer to the wiring diagram in the instructions, and then make correct connection. The false connection may result in the unexpected false operation, abnormal heating or fire.
If the contact welding, the failure of the contact or the break of the coil wire happens, other properties or lives will be threatened. Please use the double mounting sets.

6.2 Tube Packaging

When packing the relay by the tube, do not shake the tube to shock the relays, for which will result in the failure of the relays. If the package uses the stop plug, be sure to slide the stopper plug to hold the remaining relays firmly together so they would not move in the tube.

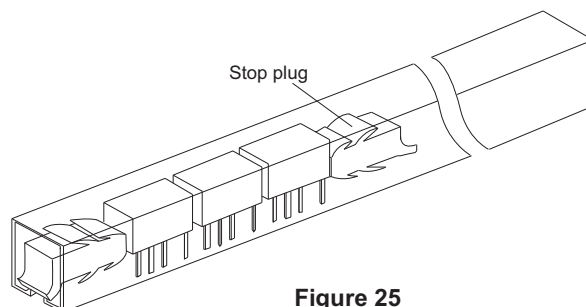

Figure 25



HONGFA RELAY

ISO9001, ISO/TS16949, ISO14001, OHSAS18001, IECQ QC 080000 CERTIFIED

CHAPTER 4 QUICK ZOOM TABLE FOR REASONS FOR FAILURE

Some common failure phenomena, failure modes, and the reasons. See table 18:

Table 18

Failure Phenomena	Failure Mode	Failure Reason
Non-operation	No current at the terminals of the coil	<ul style="list-style-type: none"> ● Breaking circuit ● Worse connected or short circuit ● Terminal welded worse
	Insufficient voltage in the circuit	<ul style="list-style-type: none"> ● Insufficient voltage supply ● Power circuit too long ● the voltage of the chosen relay too high
	Circuit unconnected	<ul style="list-style-type: none"> ● Welded worse ● Coil breaking
	Relay failure	<ul style="list-style-type: none"> ● Drop, bumped badly ● Contact failure
	Voltage polarity of the polarized relay is wrong	<ul style="list-style-type: none"> ● Bumped during the transportation ● circuit connected badly
No Release	Surplus voltage too high	<ul style="list-style-type: none"> ● Energy storage component's influence ● Leakage current or bypass current ● Surplus voltage of the semiconductor too high
	Relay failure	<ul style="list-style-type: none"> ● Drop, bumped badly ● contact failure
Unsteady Operation	Unsteady power	<ul style="list-style-type: none"> ● PARD(periodic and random deviation) ● Insufficient voltage ● Resistor beyond the tolerance
	Unsteady parameter	<ul style="list-style-type: none"> ● Drop or bumped badly ● Short form among the coils
	False operation of the relay	<ul style="list-style-type: none"> ● Something wrong with the control procedure ● The vibration excessively strong in application
NC/NO Contact Welding	Current excessively high	<ul style="list-style-type: none"> ● Load excessively high ● Surge current too high
	Contact Moving abnormally	<ul style="list-style-type: none"> ● External vibration excessively strong ● AC relay's unstable operation; with buzz ● Unstable operation
NC/NO Contact Welding	Operation frequency excessively high	
	Ambient temperature excessively high	
	Use beyond the life	
NC/NO Contact Not Closed	Contact resistance too high	<ul style="list-style-type: none"> ● Weld worse ● Contamination in the contact ● Bad using environment, contact oxidizing or sulphidizing
	No current in the contacts surface	<ul style="list-style-type: none"> ● Load circuit break ● Circuit connected worse or short circuit ● Terminal welded worse
	Use beyond the life	

Notes: when failure happens, if there's any question, please contact us.



HONGFA RELAY

ISO9001, ISO/TS16949, ISO14001, OHSAS18001, IECQ QC 080000 CERTIFIED

CHAPTER 5 ORDERING EXAMPLE

Ordering code contains the basic information of the relays. Table 19 is an ordering example of a typical Hongfa product. Please refer to the datasheet of each product for part no. selection.

	HF161F /	12	-H	T	Table 19 (XXX)
Type					
Coil voltage	5, 12, 24, 48VDC				
Contact arrangement	H: 1 Form A				
Contact material	T: AgSnO ₂		Nil: AgCdO		
Special code¹⁾	XXX: Customer special requirement		Nil: Standard		

Notes: 1) The customer special requirement express as special code after evaluating by Hongfa. e.g. (414) stands for product with coil terminal of 1.4X0.4.

